



 **LABORATORY**
ESD dot scientific inc.
PRODUCTS SALES
LabMart® Distribution Companies

Cold Storage Solutions

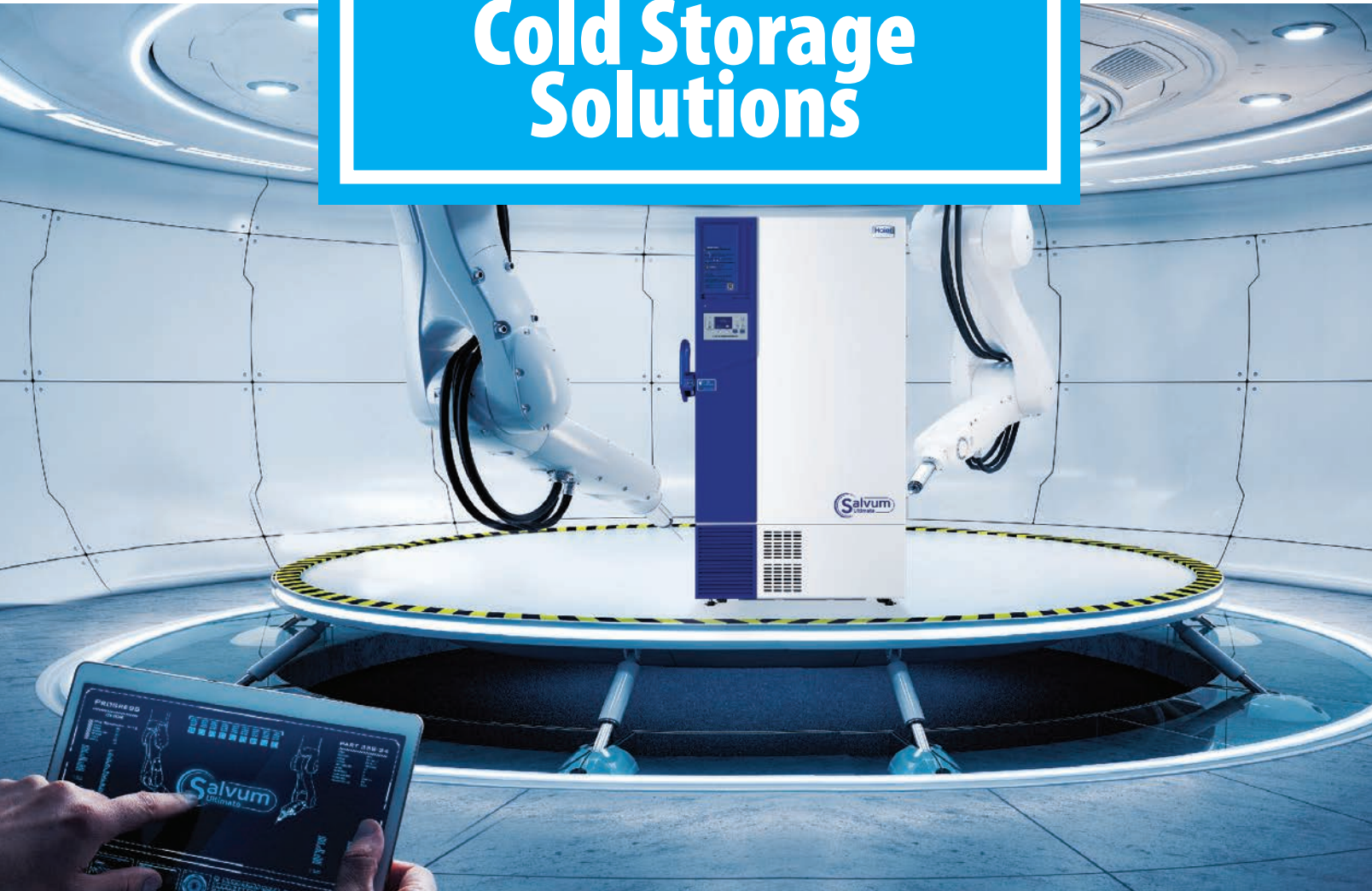



Table of Contents

Cryogenic Freezers

MVE Biological Solutions 3-19

Temperature Chart and Product Selector Guide 3

Long Term Dry Self-sustaining Cryogenic Freezer

MVE Fusion® Series 4-5

Vapor Phase Cryogenic Freezers

MVE HEco™ Series Freezers with Touch Screen 6

MVE High Efficiency -190°C Series with TEC 3000 Controller 7

MVE Vario™ Series with Touch Screen 8

Liquid Phase Cryogenic Freezers

MVE Series with TEC 3000 9

Cryogenic Freezers For In Vitro Fertilization

MVE Stock Series - 2T Models with TEC 3000 (Vapor Phase) 10

MVE Stock Series with TEC 3000 (Liquid Phase) 11

CBS Cryogenic Solutions 20-25

Isothermal Cryogenic Dry-Vapor Freezers

V-Series Full Lip Opening and Carousel Vapor Models 20-21

Cryogenic Liquid Phase Freezers - Standard Series 22

Controlled Rate Freezers (CRF)

Model 2101 23

Model IntelliRate i67C 24

Dewars

MVE - SC (Standard Capacity) Series - Compact Aluminum 12

MVE - XC (Extra Capacity) Series - Aluminum 13

MVE CryoSystem Series - Medium Vial Storage 14

MVE Research Dewars - Small, Temporary Storage ... 15

MVE Lab Series Liquid Dewars 16

MVE Doble Series - Qwick Charge Technology 17

MVE Vapor Shipper Series - Qwick Charge Technology 18

MVE CryoCube™ & BL-7 19

MVE Blood Bag Shippers 19

CBS Series 2001, 4001 and 6001 Value Added Cryosystems 25

Cryogenic Racks, Frames and Canisters 26-27

Cryogenic Safety

Gloves, Face and Eye Protection, Aprons 28

Cryogenic Accessories

MVE Cryo Cart / Workbench 11

MVE Cool Reach Retrieval Tool 40" 11,29

Sample Retrieval Devices 29

Measuring Sticks 29

Cryomarkers 29

Cryogenic Vials

Barcoded 1D 29

Tricode Barcoded Pre-set 1D & 2D 30-31

Tricode SBS Format Combo External Thread 31

Cryogenic Vials and Cap Inserts, Sterile 32-33

Cryogenic Freezer and Storage Boxes 34-36

How to Order: Specify catalog number, product description, quantity and price.
Freight Claims: Shipments leave our warehouse in good condition. Any cartons showing external damage should be refused, or the damage noted on the Bill of Lading at the time of delivery. Damaged or missing cartons must be reported within 15 days of receipt of merchandise.

Terms: Terms of payment are Net 30 days for established accounts.
Credit Cards: VISA, MasterCard, Discover and American Express as methods of payment.
Shipping: Orders are shipped via UPS Ground or common carrier, unless otherwise requested.
Warranty: The Labmart Distribution Companies are distributors of these products and in no way offer a warranty independent of the manufacturer's warranty. Nothing

in our product offering is provided an independent warranty by The Labmart Distribution Companies.

Returns: Returns will not be accepted without prior authorization from The Labmart Distribution Companies. A 15% minimum restocking fee will be made on all merchandise accepted for return on orders correctly filled. Return transportation must be paid by the customer. Requests for returns must be made within 15 days of receipt of the goods.

Contracts: Some items in this catalog are covered under state or federal contracts. Contact us for further information.

Minimum Order: \$25.00

Please note: Prices shown in the catalog are 2024 LIST prices.

Terms and Conditions



Welcome

to The LabMart Distribution Companies, where you will find a large company portfolio with small business service and support. The LabMart Distribution Companies offer a full line of Laboratory Supplies, Equipment and Chemicals from well-known industry brands, and our own LabMart Brand portfolio of quality products at competitive prices to fit all laboratory budgets.

Experience the small business service and support offered by our three distribution companies:

JH Berge, Inc.

Laboratory Product Sales, Inc. (LPS)

Dot Scientific, Inc.

We offer Complete Solutions with Differentiated Services:

- **Storage Solutions:** Certified LN2 Freezer sales and service, Energy Star freezers, refrigeration, racks, barcoded cryogenic vials, freezer boxes, tubes and more
- **Liquid Handling Solutions:** Repair and calibration service, pipettors, tips and accessories
- **Automation Solutions:** Robotic tips, plates, kitting, custom barcoding service

Our diversification includes:

- Minority Owned Small Business certified by NMSDC
- MBE (Minority Business Enterprise)
- WBE (Woman Business Enterprise) certifications through the State of Wisconsin
- SAM registered

The LabMart Distribution Companies offer electronic ordering and billing capabilities and have achieved Top Performer recognition for outstanding performance in the areas of quality, price, delivery, customer support and social responsibility. Our eCommerce platform capabilities include Jaggaer, ESM, IntraMalls, Ariba and Aquire, etc., which are used by large university systems and major pharmaceutical companies across the nation.

Thank you for shopping our Cold Storage Solutions catalog. Our dedicated field sales and customer service teams are here to help you with ALL of your laboratory product needs.

Temperature Chart

MVE Biological Solutions is the leading global manufacturer of cryogenic storage and shipping devices. More than 60 years ago, they set the standard for storage of biological materials at low temperatures. Today, they continue to exceed these standards. Customers from around the world look to MVE for excellence and innovation as they continue to make a vital contribution in today's biomedical Life Sciences industry. In this manner, MVE continues to make a vital contribution in today's biomedical Life Sciences industry.

Maximum temperature for storage of biological samples.

MATERIAL TO BE STORED	VOLUME	CONTAINER	INVENTORY CONFIGURATION	CRITICAL TEMPERATURE
■ Algae	0.5 - 1.0 mL	Cryovial	Boxes or canes	-150°C
- Blood	0.5 - 500 mL	Cryovial/Blood Bag	Boxes or canes/bag rack	-150°C
■ Cells:				
- Animals / Human	0.5 - 1.0 mL	Cryovial	Boxes or canes	-150°C
- Plant	0.5 - 1.0 mL	Cryovial	Boxes or canes	-150°C
- Embryos		Straw	Canes	-150°C
■ Fungi:				
- Mycelium	0.5 - 1.0 mL	Cryovial	Boxes or canes	-150°C
■ Hybridomas	0.5 - 1.0 mL	Cryovial	Boxes or canes	-150°C
■ Phage:	16.00 (406)	16.00 (406)	20.70 (527)	25.13 (638)
- Libraries	0.5 - 1.0 mL	Cryovial	Boxes or canes	-150°C
- Protozoa	0.5 - 1.0 mL	Cryovial	Boxes or canes	-150°C
■ Viruses: Animal In Cells	0.5 - 1.0 mL	Cryovial	Boxes or canes	-150°C

Product Selector Guide

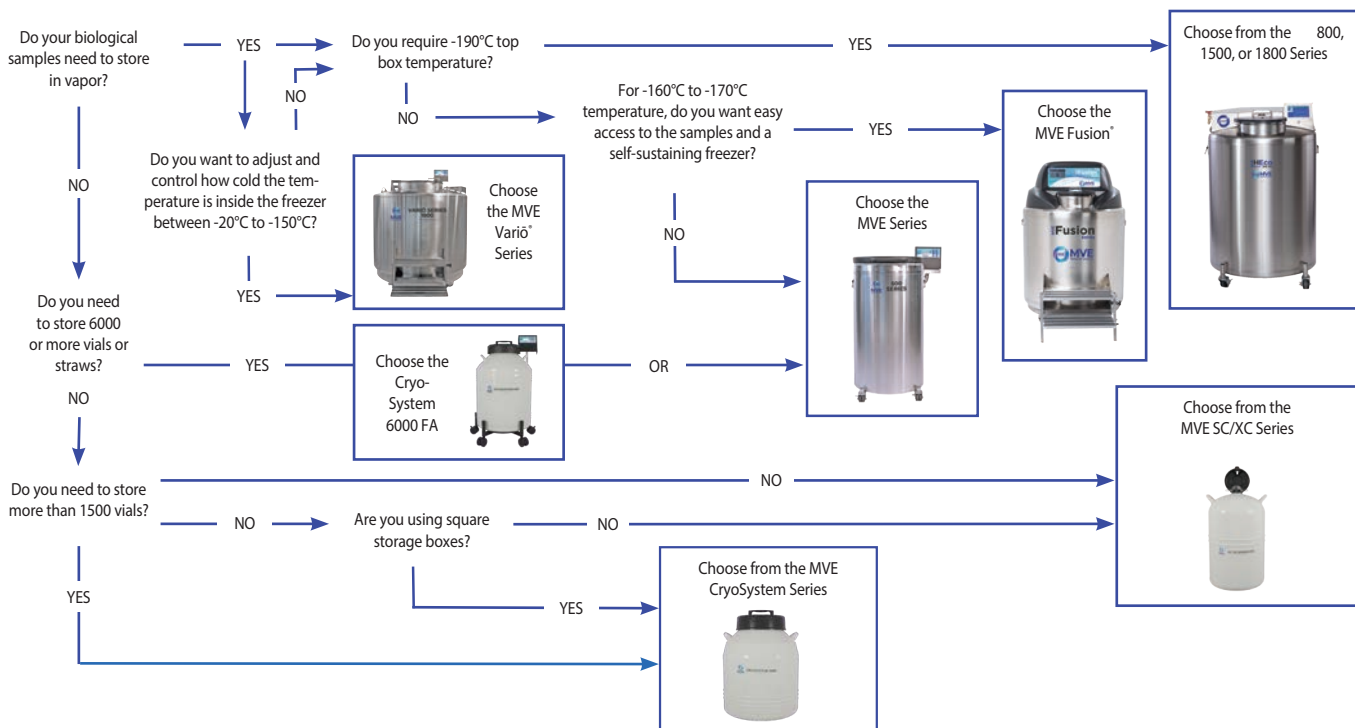

The MVE Fusion® Cryogenic Freezer

The world's first self-sustaining cryogenic freezer

- Long-term dry storage that requires no ongoing LN₂ supply
- Ideal for remote locations, isolated rooms, high elevation facilities, and facilities with limited jacketed pipe infrastructures
- 2 year parts, 5 year vacuum warranty

Eliminate monthly LN₂ costs from your budget!

MVE Fusion® Freezer			
Maximum Storage Capacity			
■ 1.2 & 2 ml Vials (Internally Threaded)	31,200		
■ Number of Racks 100 cell boxes	20		
■ Number of Racks 25 cell boxes	16		
■ Number of Stages per Rack	13		
Performance			
■ LN ₂ Capacity L	50 (inner pressure vessel)		
Unit Dimensions			
■ Neck Opening in. (mm)	12.5 (318)		
■ Usable Internal Height in. (mm)	29.6 (752)		
■ Inner Diameter in. (mm)	38.4 (975)		
■ Overall Height in. (mm)	65 (1625)		
■ Overall Depth in. (mm)	57 (1450)		
■ Liftover Height in. (mm)	37.1 (944)		
■ Door Width Requirement** in. (mm)	43.5 (1105) with handles		
■ Weight Empty est. lb. (kg)	750 (340) estimated		
■ Weight Liquid Full* (Freezer with 50L and Cryocooler) est. lb. (kg)	830 (377) without racks estimated		
Blood Bag Capacities	Total Bags	Bags/Frame	No. Frames
■ 791 OS/U (25 ml)	2296	7	328
■ 4R9951 (50 ml)	1484	7	212
■ 4R9953 (250 ml)	752	4	188
■ 4R9955 (500 ml)	592	4	148
■ DF200 (200 ml)	416	4	104
■ DF700 (700 ml) (will not fit through neck opening)			

FIVE Year Vacuum Warranty • TWO Year Standard Warranty

* Without inventory

**Minimum width required for vessel to pass through opening. Footprint may vary. Contact Tech Service for detailed drawings. Conforms to MDD 93/42/EEC, the Medical Device Directive for the EU. Freezer systems UL/C-UL Listed.



Cat. No.	Description	List Price
21135284	MVE Fusion 1500 with Cryocooler, Hose and 2-tier Step	\$62,528.00
21312104	MVE Fusion Freezer IQOKPQ Validation Package	\$ 2,251.00

Long-term Dry Self-Sustaining Cryogenic Freezer

Assessories

MVE Fusion™ Rack Systems	Description	Cat. No.	List Price
Large Rack (Capacity: 20 Racks)	13-2 LARGE RACK	10544431	\$ 130.00
Mini Rack (Capacity: 16 Racks)	13-2 MINI RACK	10544685	\$ 123.00
MVE Fusion™ Freezer Accessories	Description	Cat. No.	List Price
LN2 Hose w/Safety Relief Valve Standard w/New Fusion	Trans Hose 1/2"x6' OAL TYPE 1-W300PSI RV	10669293	\$ 418.00
LN2 Hose w/o Safety Relief Valve (Only to fill through the neck - Do not connect to Inlet)		9713109	\$ 301.00
Extra Large Phase Separator	1 5/8" Dia. x 4" Long	10615869	\$ 231.00
Relief Valve (Fusion)	Relief Valve	21481696	\$ 119.00
Deflector, for Relief Valve	RV Deflector	11885422	\$ 85.00
Clamp, for Deflector	Clamp	11885431	\$ 6.00
Lid Assy Fusion 1500	Lid w/Ballast Disc & Magnet	21183724	\$2,147.00
Lid Gasket Sold per Foot (3 Feet Required)	EPDM Foam .5" x .75"	20763936	\$ 18.00 per ft
1500 Neck Round Rubber Gasket	Neck Seal Gasket Black	21287912	\$ 381.00
Temperature Probe - MVE T3/TS/ FUSION	Spare Temperature Probe 65" - all freezer models	20570663	\$ 240.00
Temperature Probe w/Certificate of Calibration - (Must be ordered with freezer) Certificate does not certify the calibration of the controller with the sensor installed. Controller calibration is still required.		20570663CAL	\$ 517.00
Battery Cells Only		21081273	\$ 222.00
Muffler 1/4"MPT		11499812	\$ 33.00
Muffler Deflector		11885449	\$ 32.00
Sensor Rubber Plug (Yellow)	Plug for Fusion Sensor Hole	21205789	\$ 3.00
MVE Fusion™ Power Cord	Power Cord Detachable 16/3 SJT, Volex 17502 10 B1	21398542	\$ 30.00



Rack Layout

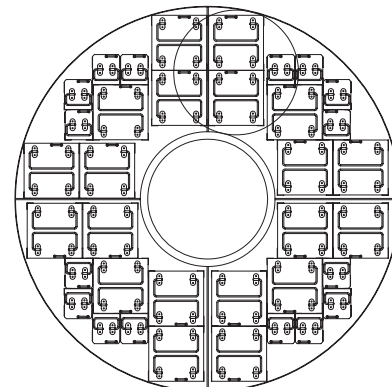

MVE HEco™ Series

With the MVE Touch Screen

- LN₂ efficiency freezers
- Fully enclosed wiring and plumbing
- Vacuum jacketed transfer hose
- Dry sample storage
- -190°C top box temperature
- Low liftover height
- 2 year parts, 5 year vacuum warranty
- Also available with TEC 3000

HEco™ 800 Series with Single Step

Cat. No.	Model Number/Description	Max Qty. Large Racks & 100-place 2" boxes	Max Qty. Mini Racks & 25-place 2" boxes	List Price
21093061	MVE HEco 815P-190AF-TS, 15,600 vial capacity	12 racks, 12 shelves/rack	4 racks, 12 shelves/rack	\$30,076.00
21093058	MVE HEco 818P-190AF-TS, 18,200 vial capacity	12 racks, 14 shelves/rack	4 racks, 14 shelves/rack	\$30,581.00
21093055	MVE HEco 819P-190AF-TS, 19,500 vial capacity	12 racks, 15 shelves/rack	4 racks, 15 shelves/rack	\$30,888.00
20820733	Optional 2-Tier Step			\$ 2,441.00
21107430	Optional HEco 800 Magnetic Lid Lock			\$ 3,125.00

HEco™ 1500 Series with Two-tier Folding Step

Cat. No.	Model Number/Description	Max Qty. Large Racks & 100-place 2" boxes	Max Qty. Mini Racks & 25-place 2" boxes	List Price
21093084	MVE HEco 1536P-190AF-TS, 36,400 vial capacity	24 racks, 13 shelves/rack	16 racks, 13 shelves/rack	\$40,031.00
21093081	MVE HEco 1539P-190AF-TS, 39,200 vial capacity	24 racks, 14 shelves/rack	16 racks, 14 shelves/rack	\$44,706.00
21093078	MVE HEco 1542R-190AF-TS, 42,000 vial capacity	26 racks, 14 shelves/rack	16 racks, 14 shelves/rack	\$45,022.00
21087059	Optional HEco 1500 Magnetic Lid Lock			\$ 3,298.00

HEco™ 1800 Series with Two-tier Folding Step

Cat. No.	Model Number/Description	Max Qty. Large Racks & 100-place 2" boxes	Max Qty. Mini Racks & 25-place 2" boxes	List Price
21093075	MVE HEco 1879P-190AF-TS, 79,950 vial capacity	54 racks, 13 shelves/rack	30 racks, 13 shelves/rack	\$64,954.00
21093072	MVE HEco 1881R-190AF-TS, 81,900 vial capacity	60 racks, 13 shelves/rack	12 racks, 13 shelves/rack	\$70,280.00
21093068	MVE HEco 1892P-190AF-TS, 92,250 vial capacity	54 racks, 15 shelves/rack	30 racks, 15 shelves/rack	\$75,400.00
21093064	MVE HEco 1894R-190AF-TS, 94,500 2mL vial capacity	60 racks, 15 shelves/rack	12 racks, 15 shelves/rack	\$80,493.00
21087060	Optional HEco 1800 Magnetic Lid Lock			\$ 3,454.00

Accessories

Cat. NO.	Description	List Price
11864171	Optional Battery Backup for all HECO models	\$ 1,027.00



Rack Layout

Square Rack Layout (P)

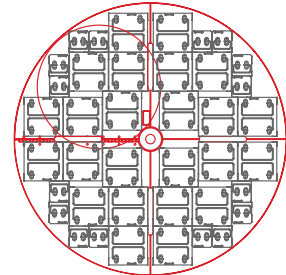

4R9951 Layout (R)

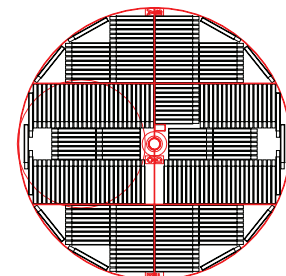

MVE High Efficiency – 190°C Series

With the TEC 3000

- Large LN₂ capacity at vapor platform
- Dry sample storage
- Fully enclosed wiring and plumbing
- Low liftover height
- -190°C top box temperature
- 1500 and 1800 series include 2-tiered steps
- 2 year parts, 5 year vacuum warranty

High Efficiency 800 Series - Stores over 1800 Blood Bags

Cat. No.	Model Number/Description	Max Qty. Large Racks & 100-place 2" boxes	Max Qty. Mini Racks & 25-place 2" boxes	List Price
11369946	MVE 815P-190AF-GB, 15,600 vial capacity	12 racks, 12 shelves/rack	4 racks, 12 shelves/rack	\$30,077.00
13335846	MVE 819P-190AF-GB, 19,500 vial capacity	12 racks, 12 shelves/rack	4 racks, 15 shelves/rack	\$30,888.00
20820733	Optional removable 2-tier step assembly			\$ 2,441.00
13384883	Optional magnetic lid lock assembly			\$ 3,125.00

High Efficiency 1500 Series - Stores over 3100 Blood Bags

Cat. No.	Model Number/Description	Max Qty. Large Racks & 100-place 2" boxes	Max Qty. Mini Racks & 25-place 2" boxes	List Price
11360247	MVE 1536P-190AF-GB, 36,400 vial capacity	24 racks, 13 shelves/rack	16 racks, 13 shelves/rack	\$40,031.00
20538462	MVE 1539R-190AF-GB, 39,200 vial capacity	24 racks, 14 shelves/rack	16 racks, 14 shelves/rack	\$40,189.00
11894505*	MVE 1539P-190AF-GB, 39,200 vial capacity	24 racks, 14 shelves/rack	16 racks, 14 shelves/rack	\$44,707.00
13740104	MVE 1542R-190AF-GB, 42,000 vial capacity	26 racks, 14 shelves/rack	16 racks, 14 shelves/rack	\$45,022.00
13384921	Optional magnetic lid lock assembly			\$ 3,298.00

High Efficiency 1800 Series - Stores over 8400 Blood Bags

Cat. No.	Model Number/Description	Max Qty. Large Racks & 100-place 2" boxes	Max Qty. Mini Racks & 25-place 2" boxes	List Price
13814943	MVE 1879P-190AF-GB, 79,950 vial capacity	54 racks, 13 shelves/rack	30 racks, 13 shelves/rack	\$67,533.00
13371169	MVE 1881R-190AF-GB, 81,900 vial capacity	60 racks, 13 shelves/rack	12 racks, 13 shelves/rack	\$70,280.00
13811849	MVE 1892P-190AF-GB, 92,250 vial capacity	54 racks, 15 shelves/rack	30 racks, 15 shelves/rack	\$75,400.00
13436170	MVE 1894R-190AF-GB, 94,500 vial capacity	60 racks, 15 shelves/rack	12 racks, 15 shelves/rack	\$80,493.00
13384939	Optional magnetic lid lock assembly			\$ 3,454.00

Accessories

Cat. No.	Description	List Price
12885791	Optional Battery backup for all HE models	\$ 1,027.00
21837350	Vacuum Jacketed Hose 3/8" (Hose VJ)	\$ 2,776.00

*also available with rectangular inventory dividers



MVE Variō™ Series

With Touch Screen

- Energy efficient alternative for ULT to cryogenic storage
- Completely dry sample storage
- Consistent temperature even with lid open
- No thermal load; no heat introduced into room and no additional HVAC required
- 2 year parts, 5 year vacuum warranty



MVE Variō™ Series					
	1536P	1539R	1879P	1881R	1894R
Maximum Storage Capacity					
■ 1.2 & 2 ml Vials (Internally Threaded)	36,400	39,000	79,950	81,900	94,500
■ Quantity of Large Racks 100 cell boxes	24	26	54	60	60
■ Quantity of Mini Racks 25 cell boxes	16	16	30	12	12
■ Number of Shelves per Rack	13	13	13	13	15
■ Power consumption (cont.) W	8	8	8	8	8
Unit Dimensions					
■ Neck Opening in. (mm)	17.5 (445)	17.5 (445)	25.0 (635)	25.0 (635)	25.0 (635)
■ Usable Internal Height in. (mm)	28.8 (732)	29.3 (745)	29.5 (749)	29.2 (741)	34.2 (868)
■ Inner Diameter in. (mm)	38.5 (978)	38.5 (978)	56.0 (1,422)	54.8 (1,391)	54.8 (1,391)
■ Overall Height in. (mm)	61.3 (1,556)	61.3 (1,556)	62.1 (1,577)	61.3 (1,556)	66.3 (1,683)
■ Door Width Requirement (mm)	42.0 (1,067)	42.0 (1,067)	60.0 (1,524)	60.0 (1,524)	60.0 (1,524)
■ Weight Empty lb. (kg)	690 (313)	690 (313)	1,606 (728)	1,721 (781)	1,721 (781)

Blood Bag Capacities	Total Bags			Total Bags			Total Bags			Total Bags			Total Bags		
	Bags/Frame	No. Frames		Bags/Frame	No. Frames		Bags/Frame	No. Frames		Bags/Frame	No. Frames	Bags/Frame	No. Frames		
■ 791 OS/U Medsep (25 ml)	3,080	7	440	2,786	7	398	5,866	7	838	5,628	7	804	6,432	8	804
■ 4R9951 (50 ml)	1,488	6	248	1,446	6	241	2,952	6	492	2,940	6	490	3,920	8	490
■ 4R9953 (250 ml)	812	4	203	768	4	192	1,584	4	396	1,608	4	402	2,010	5	402
■ 4R9955 (500 ml)	608	4	152	576	4	144	1,104	4	276	1,240	4	310	1,550	5	310
■ DF200 (200 ml)	496	4	154	488	4	122	960	4	240	984	4	246	1,230	5	246
■ DF700 (700 ml)	256	4	64	204	4	66	504	4	126	544	4	136	680	5	136

MVE Variō™ 1500 with Touch Screen		
Cat. No.	Model Number/ Description	List Price
21000856	MVE Variō 1536P-TS	\$42,092.00
21000854	MVE Variō 1539R-TS	\$42,912.00
13384921	Optional Magnetic Lid Assembly Lock	\$ 3,298.00

MVE Variō™ 1800 with Touch Screen		
Cat. No.	Model Number/ Description	List Price
21000851	MVE Variō 1879P-TS	\$72,138.00
21000852	MVE Variō 1881R-TS	\$75,002.00
21000857	MVE Variō 1894R-TS	\$81,947.00
13384939	Optional Magnetic Lid Assembly Lock	\$ 3,454.00

Accessories		
Cat. No.	Description	List Price
12885791	Optional Battery backup for all Variō models	\$ 1,027.00
21837350	Vacuum Jacketed Hose 3/8" (Hose VJ)	\$ 2,776.00

Rack Layout
Square Rack Layout (P)

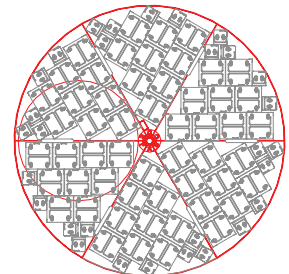

4R9951 Layout (R)

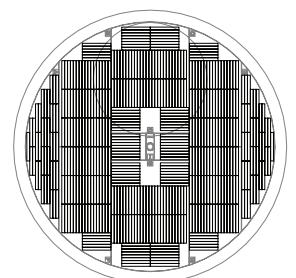

STANDARD
OPTIONAL

MVE Series

With TEC 3000

- Large LN₂ capacity
- Liquid sample storage
- Wide neck opening
- Low liftover height
- 2 year parts, 5 year vacuum warranty

MVE Series					
	MVE 205	MVE 510	MVE 616	MVE 1426	MVE 1839
Maximum Storage Capacity					
■ 1.2 & 2 ml Vials (Internally Threaded)	5,200	10,400	16,900	26,650	39,000
■ Number of Racks 100 cell boxes	4	7	12	18	28
■ Number of Racks 25 cell boxes	-	4	4	10	8
■ Number of Stages per Rack	13	13	13	13	13
■ LN ₂ Capacity L	95	166	240	388	673
Unit Dimensions					
■ Neck Opening in. (mm)	16.00 (406)	20.70 (527)	25.10 (638)	31.75 (806)	39.40 (1002)
■ Usable Internal Height in. (mm)	28.9 (735)	30.0 (762)	29.5 (749)	29.3 (745)	33.6 (854)
■ Inner Diameter in. (mm)	16.00 (406)	20.70 (527)	25.1 (638)	31.75 (806)	39.40 (1002)
■ Overall Height w/ AutoFill in. (mm)	46.3 (1176)	46.7 (1185)	45.8 (1161)	46.8 (1188)	54.0 (1372)
■ Door Width Requirement** in. (mm) Outer Dimensions	23.6x22.7 (601x577)	30.6x29.7 (778x754)	33.5x34.6 (852x878)	40x41.6 (1017x1056)	46.8x48.9 (1187x1242)
■ Weight Empty lb. (kg)	195 (88)	281 (127)	320 (145)	490 (222)	750 (341)
■ Weight Liquid Full* lb. (kg)	365 (166)	577 (262)	748 (339)	1181 (536)	1950 (885)

Blood Bag Capacities	Total Bags			Total Bags			Total Bags			Total Bags			Total Bags		
	Bags/Frame	No. Frames	No. Frames	Bags/Frame	No. Frames	No. Frames	Bags/Frame	No. Frames	No. Frames	Bags/Frame	No. Frames	No. Frames	Bags/Frame	No. Frames	No. Frames
■ 791 OS/U Medsep (25 ml)	539	7	77	882	7	126	1,372	7	196	2,226	7	318	3,968	8	496
■ 4R9951 (50 ml)	228	6	38	420	6	70	612	6	102	924	6	154	1,856	8	232
■ 4R9953 (250 ml)	128	4	32	224	4	56	336	4	84	512	4	128	1,010	5	202
■ 4R9955 (500 ml)	96	4	24	160	4	40	248	4	62	424	4	106	770	5	154
■ DF200 (200 ml)	80	4	20	128	4	32	200	4	50	336	4	84	610	5	122
■ DF700 (700 ml)	40	4	10	68	4	17	116	4	29	168	4	42	380	5	76

MVE Series		
Cat. No.	Model Number/ Description	List Price
11004373	MVE 205AF-GB	\$14,625.00
10544837	Optional Vapor Platform	\$ 518.00
11905075	MVE 510AF-GB	\$12,781.00
10544853	Optional Vapor Platform	\$ 614.00
11527342	MVE 616AF-GB	\$13,864.00
11509726	Optional Vapor Platform	\$ 604.00
11655301	MVE 1426AF-GB	\$21,405.00
10544888	Optional Vapor Platform	\$ 718.00
11922449	MVE 1839AF-GB	\$30,062.00
10544909	Optional Vapor Platform	\$ 1,010.00
Accessories		
11864171	Optional Battery backup for all MVE models	\$ 1,027.00
21837350	Vacuum Jacketed Hose 3/8" (Hose VJ)	\$ 2,776.00



Rack Layout

4R9953 Layout

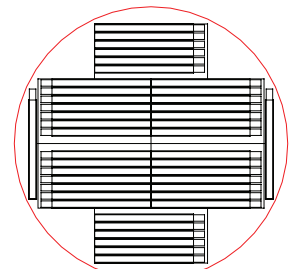

DF700 Layout

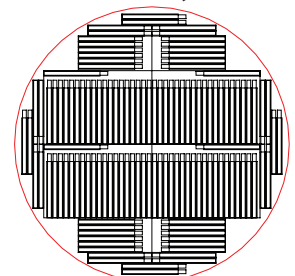

Vapor Phase MVE Stock Series - 2T Models

With TEC 3000

- Low liftover height • Large LN₂ Capacity
- Optional Battery Backup
- 2 year parts, 5 year vacuum warranty



Vapor Phase MVE Stock Series - 2T Models				
	MVE 103	MVE 816P-2T-190	MVE 1842P-150	MVE 1877P-2T-150
Maximum Storage Capacity				
■ 1.2 & 2 ml Vials (Internally Threaded)	—	10,500	—	—
■ High Security Straw Capacity (0.5 ml)	7,728	31,584	—	347,424
■ Number of Canisters (73 mm)	23	94	—	517
■ Goblets/Canister : Straws/Goblet	2:168	2:168	2:168	4:168
■ Number of SUC-1 Canisters (2.5"x2.5"x11)	22	115	294	539
■ Number of 1.2 ml Vials on Canes	3,168	16,560	42,336	77,616
■ Number of 2.0 ml Vials on Canes	1,760	9,200	23,520	43,120
■ Number of 1/2 cc Straws 10/cane	6,820	35,650	91,140	167,090
■ LN ₂ Capacity at Platform Vapor L est.	-	56	-	250
■ LN ₂ Capacity w/o Inventory L est.	39	381	872	1456
Unit Dimensions				
■ Neck Opening in. (mm)	16.0 (406)	12.5 (317)	25.0 (635)	25.0 (635)
■ Usable Internal Height in. (mm)	12.0 (305)	13.0 (330) per level	13.0 (330)	13.0 (330) per tray
■ Inner Diameter in. (mm)	16.00 (406)	28.70 (728) top tier 27.70 (702) bottom tier	56.1 (1425)	56.25 (1429) top and bottom tiers
■ Overall Height with Auto Fill in. (mm)	16.4 (415)	58.0 (1473)	51.1 (1296)	64.6 (1639)
■ Door Width Requirement in. (mm) Outer Dims	18 (457)	32 (813)	60 (1524)	60 (1524)
■ Weight Empty lb. (kg)	48 (22)	475 (215)	1167 (530)	1721 (781)
■ Weight Liquid Full lb. (kg) est.	117 (53)	1155 (524)	2721 (1234)	4316 (1958)

Rack Layouts

115 SUC Boxes Total

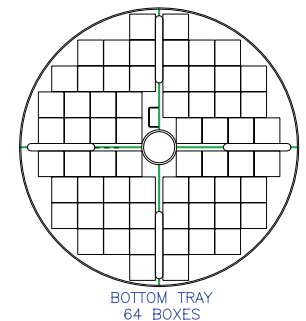
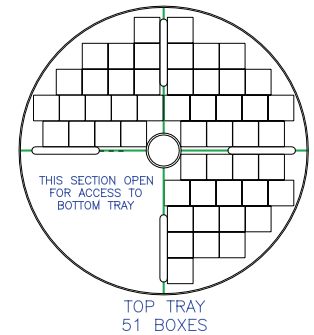

Vapor Phase MVE Stock Series - 2T Models		
Cat. No.	Model Number/Description	List Price
13476657	MVE 816P-2T-190AF-GB	\$34,484.00
13820981	MVE 1877-2T-150AF-GB	\$66,360.00
12885791	Optional Battery backup	\$ 1,027.00
21837350	Vacuum Jacketed Hose 3/8" (Hose VJ)	\$ 2,776.00

Cryogenic Freezers for In Vitro Fertilization

Liquid Phase MVE Stock Series

With TEC 3000

- Designed for liquid storage, but most MVE Stock Series can be used to store in vapor*
- 2 year parts, 5 year vacuum warranty

Liquid Phase MVE Stock Series		
Cat. No.	Model Number/Description	List Price
9918669	MVE 103, no TEC 3000, lift off lid	\$ 5,952.00
13817440	MVE 1842P-150-150AF-GB	\$54,115.00
20969812	Canister SQ SS MVE 5-2 Large for 1842 models	\$ 129.00

* Verify temperature requirements if you are going to store vapor in the MVE or Stock Series.



Tank Features
816P-2T-190

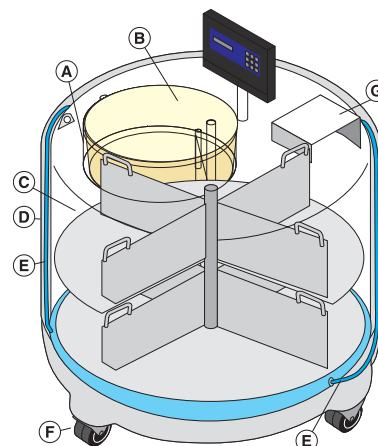

- A** Offset neck design minimizes liquid nitrogen consumption
- B** Lightweight composite lid is scratch and dent resistant
- C** Two level rotating tray provides easy access to samples
- D** Stainless steel construction reduces maintenance
- E** Annular (internal) filling lines minimizes frost build up and reduces maintenance requirements
- F** Durable casters equipped with brakes
- G** Lid Stand

MVE CryoCart/ Workbench

- Approximate hold time of 18 hours with lid on
- Temperature monitor with type T Thermocouple
- Traceable calibration certificate with RS232 PC interface
- LN₂ transfer hose connection with ball valve and relief valve



Cat. No.	Description	List Price
14448703	MVE Cryo Cart	\$22,694.00

Cool Reach Retrieval Tool

- Retrieves sample vials, etc. that have fallen into LN₂



Cat. No.	Description	List Price
13051579	Cool Reach - Retrieval Tool - 40" (includes handle)	\$ 286.00



MVE - SC (Standard Capacity) Series - Compact Aluminum Dewar

- Long term liquid storage and preservation
- Popular for IVF
- Low LN₂ consumption
- Strong, lightweight construction
- 2 year parts, 5 year vacuum warranty
- SC 20/20 includes Bend Don't Break™ durability feature



MVE SC Series	BEST SELLER		
	SC 3/3	SC 11/7	SC 20/20 Signature
Maximum Storage Capacity			
■ Number of Canisters	6	6	6
■ Number of 1/2 cc straws 10/cane	—	660	660
■ Number of 1/2 cc straws 1 Level Bulk	440	879	879
■ Number of 1/4 cc straws	—	210	210
■ LN ₂ Capacity L	3.6	11.0	20.5
■ Static Evaporation Rate L/day	0.13	0.16	0.085
■ Static Holding Time days	17	43	150
Unit Dimensions			
■ Neck Opening in. (mm)	2.18 (55)	2.18 (55)	2.16 (55)
■ Overall Height in. (mm)	16.0 (406)	21.6 (549)	26.0 (660)
■ Outer Diameter in. (mm)	8.7 (222)	10.2 (260)	14.5 (368)
■ Canister Height in. (mm)	5.0 (127)	11.0 (279)	11.0 (279)
■ Canister Diameter in. (mm)	1.65 (41.9)	1.65 (41.9)	1.65 (41.9)
■ Weight Empty lb. (kg)	8 (3.6)	17 (7.7)	22.5 (10.2)
■ Weight Full lb. (kg)	14.4 (6.5)	36.6 (16.6)	58.99 (26.7)

Tank Features

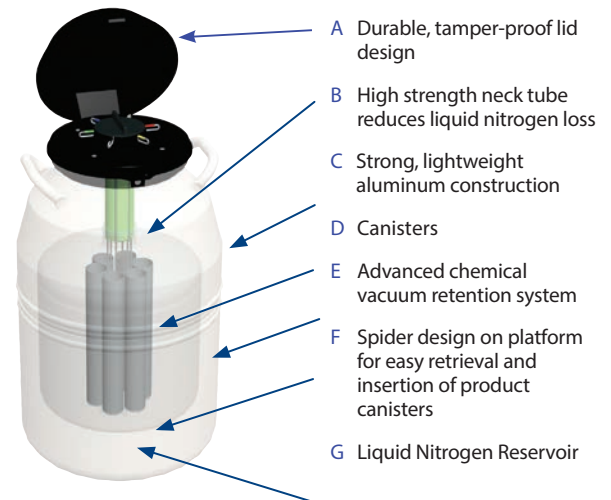

MVE SC Series		
Cat. No.	Model Number/Description	List Price
9918009	SC 3/3 with (6) 5" (127 mm) canisters	\$1,193.00
9918499	SC 11/7 with (6) 11" (279mm) canisters	\$1,223.00
20861774	SC 20/20 SIGNATURE with (6) 11" (279mm) canisters	\$1,463.00
10829621	SC 35/24 with (6) 11" (279mm) canisters	\$1,969.00
10937403	Roller Based for SC 35/24 (required)	\$ 415.00
10623201	Center canister for SC 20/20, XC-20, 35/24, 11/7	\$ 53.00

MVE - XC (Extra Capacity) Series - Aluminum Dewar

- Long term liquid storage and preservation
- Popular for IVF
- Low LN₂ consumption
- Strong, lightweight construction
- 2 year parts, 5 year vacuum warranty



MVE - XC Series		BEST SELLER					
	XC 20 Signature	XC 32/8	XC 33/22	XC 34/18	XC 47/11-6SQ	XC 47/11-6	XC 47/11-10
Maximum Storage Capacity							
■ Number of Canisters	6	9	6	6	6 sq.	6	10
■ Number of 1/2 cc Straws 10/cane	660	2,520	1,260	2,100	—	4,500+	3,500
■ Number of 1/2 cc Straws 1 Level Bulk	879	3,960	1,764	3,000	—	6,216	5,000
■ Number of 1/2 cc Straws 2 Level Bulk	1,680	—	—	630	—	1,320	1,050
■ Number of 1.2 & 2.0 ml Vials 5/cane	210	855	360	—	750	—	—
■ LN ₂ Capacity L	20.5	32.0	33.4	34.8	47.4	47.4	47.4
■ Static Evaporation Rate L/day	0.090	0.35	0.14	0.18	0.39	0.39	0.39
■ Normal Working Duration, Full Days	142	57	154	123	76	76	76
Unit Dimensions							
■ Neck Opening in. (mm)	2.18 (55.4)	3.81 (97)	2.75 (70)	3.50 (89)	5.00 (127)	5.00 (127)	5.00 (127)
■ Overall Height in. (mm)	26.0 (660)	21.5 (546)	26.0 (660)	26.6 (675)	26.5 (673)	26.5 (673)	26.5 (673)
■ Overall Inner Height in. (mm)	—	—	—	—	—	—	—
■ Outer Diameter in. (mm)	14.5 (368)	18.2 (464)	18.2 (464)	18.2 (464)	20.0 (508)	20.0 (508)	20.0 (508)
■ Canister Height in. (mm)	11/5 (279/127)	11 (279)	111 (279)	11 (279)	—	11 (279)	11 (279)
■ Canister Diameter in. (mm)	1.65 (41.9)	2.62 (67)	2.22 (56)	2.81 (71)	—	4.00 (102)	2.81 (71)
■ Weight Empty lb. (kg)	22 (10)	30 (13.6)	34 (15.4)	34 (15.4)	42 (19.0)	42 (19.0)	42 (19.0)
■ Weight Full lb. (kg)	58.4(26.5)	87.0 (39.5)	94.0 (42.5)	96.0 (43.5)	120.4 (54.6)	120.4 (54.6)	120.4 (54.6)



MVE XC Series		
Cat. No.	Model Number/Description	List Price
20997986	XC 20 Signature Series with (6) 11" (279mm) canisters	\$1,219.00
9918449	XC 32/8 with (9) 11" (279mm) canisters	\$2,241.00
9918069	XC 33/22 with (6) 11" (279mm) canisters	\$1,829.00
10743027	XC 34/18 with (6) 11" (279mm) canister	\$1,781.00
10719924	XC 47/11-6 with (6) 11" (279mm) canisters	\$2,304.00
13346449	XC 47/11-6SQ with (6) mini square rack, (2" Mini Boxes) 5-Tier-25 cell	\$2,993.00
10725435	XC 47/11-10 with (10) 11" (279mm) canisters	\$2,340.00
10937391	Roller Base - XC20 Signature Series	\$ 415.00
10937403	Roller Base - XC 32/8, XC 33/22, XC 34/18	\$ 415.00
10937411	Roller Base - XC 47/11-6, XC 47/11-6SQ, XC 47/11-10	\$ 415.00

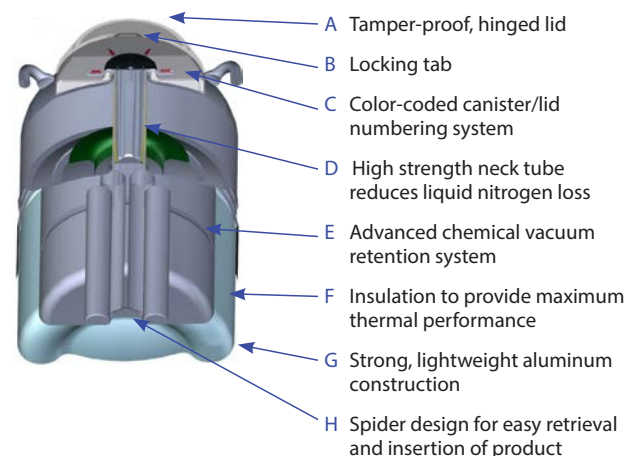

MVE CryoSystem Series

- Medium vial storage capacity
- Low liquid nitrogen consumption
- 2 year parts, 3 year vacuum warranty



MVE CryoSystem Series				BEST SELLER
	CryoSystem 750	CryoSystem 2000	CryoSystem 4000	CryoSystem 6000
Maximum Storage Capacity				
■ Number of Canisters	6	4	4	6
■ Number of 1.2 & 2.0 ml vials 100/box	—	2,000	4,000	6,000
■ Number of 1.2 & 2.0 ml vials 25/box	750	—	—	—
■ Boxes per Rack	5	5	10	10
■ LN ₂ Capacity w/o Inventory L est.	47	61	121	175
■ LN ₂ Capacity w/Inventory L est.	45	51	111	150
■ Static Evaporation Rate L/day	0.39	0.85	0.99	0.99
■ Working Duration Full Days	76	38	66	104
Unit Dimensions				
■ Neck Opening in. (mm)	5.0 (127)	8.5 (216)	8.5 (216)	8.5 (216)
■ Overall Height in. (mm)	26.50 (673)	27.25 (692)	38.00 (965)	37.9 (963)
■ Outer Diameter in. (mm)	20 (508)	22 (559)	22 (559)	26.5 (673)
■ Weight Empty lb. (kg)	42 (19.0)	58 (26.3)	81 (36.7)	103 (46.7)
■ Weight Full lb. (kg)	126 (57)	182 (82.5)	300 (136)	425 (193)

MVE CryoSystem Series		
Cat. No.	Model Number/Description	List Price
11886450	Cryosystem 750 with (6) inventory racks for (30) mini boxes	\$ 2,959.00
10650200	Cryosystem 2000 with (4) inventory racks for (20) large boxes	\$ 4,757.00
10650197	Cryosystem 4000 with (4) inventory racks for (40) large boxes	\$ 5,434.00
10718067	Cryosystem 6000 with (6) inventory racks for (60) large boxes	\$ 6,130.00
10937411	Roller Base - Cryosystem 750	\$ 415.00
10937420	Roller Base - Cryosystem 2000 and 4000	\$ 415.00
10937438	Roller Base - Cryosystem 6000	\$ 415.00
14796775	Cryosystem 6000 Full Auto w/TEC3000/Roller Base/Transfer Hose with 6 racks for (60) large boxes	\$12,019.00

Tank Features

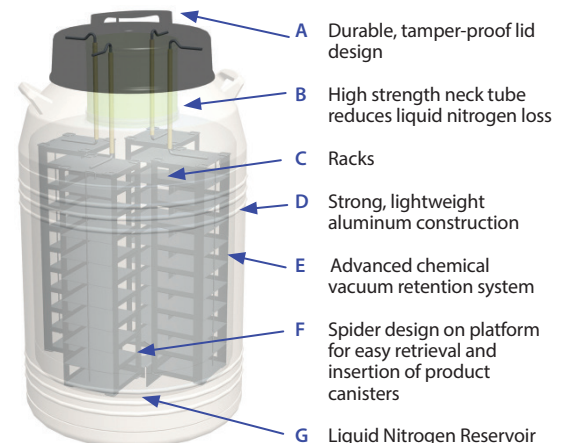

MVE Research Dewars

- Small thermal dewar for temporary storage
- For easy, safe transport of LN₂ and samples within facilities
- All stainless steel construction
- Vacuum-insulated for long static hold times
- 90 day warranty
- Lids sold separately



MVE Research Dewars						
	RD-6	RD-3	RD-2	RD-1	RD-1W	RD-0.5
Performance						
■ LN ₂ Capacity L est.	6	3	2	1	1	0.5
■ Handle	yes	yes	yes	yes	yes	no
Unit Dimensions						
■ Neck Opening in. (mm)	7.3 (185)	7.3 (185)	3.9 (99)	3.3 (84)	3.9 (99)	2.6 (66)
■ Inner Diameter in. (mm)	7.3 (185)	7.3 (185)	3.9 (99)	3.3 (84)	3.9 (99)	2.6 (66)
■ Outside Diameter in. (mm)	7.8 (198)	7.8 (198)	4.8 (122)	4.3 (109)	4.8 (122)	3.4 (86)
■ Usable Internal Height in. (mm)	10.6 (269)	6.3 (160)	7.1 (180)	6.2 (157)	6.1 (155)	7.1 (180)
■ Overall Height in. (mm)	11.8 (300)	7.5 (191)	12.3 (312)	9.1 (231)	7.0 (178)	8.0 (203)
■ Weight Empty lb. (kg)	4.4 (2.0)	3.3 (1.5)	1.8 (0.8)	1.1 (0.5)	1.1 (0.5)	0.7 (0.3)
■ Weight Liquid Full lb. (kg)	15.0 (6.8)	8.6 (3.9)	5.3 (2.4)	2.9 (1.3)	2.9 (1.3)	1.5 (0.7)
■ NER without Cover L/Hr	0.4	0.2	0.1	0.1	0.2	0.1

MVE Research Dewars		
Cat. No.	Model Number/Description	List Price
13982242	0.5 Liter Dewar	\$ 699.00
1392251	1.0 Liter Dewar	\$ 787.00
13982269	1.0 Liter Dewar (Wide Mouth)	\$ 787.00
13982277	2.0 Liter Dewar	\$ 953.00
13982285	3.0 Liter Dewar	\$1,490.00
13982293	6.0 Liter Dewar	\$1,738.00
13976344	Spare Cork and Cover for RD-0.5	\$ 228.00
13976379	Spare Cork and Cover for RD-1	\$ 228.00
13976387	Spare Cork and Cover for RD-1W and RD-2	\$ 228.00
21007715	Stainless Steel Lid Only for RD-3 and RD-6	\$ 228.00

POPULAR!

MVE Lab Series Liquid Dewars

- Convenient storage and dispensing of LN₂
- Super insulated for low LN₂ consumption
- Dispensing devices available
- 2 year parts, 5 year vacuum warranty



MVE Lab Series Liquid Dewars

	LAB 4	LAB 5	LAB 10	LAB 20	LAB 30	LAB 50
Performance						
■ LN ₂ Capacity L	4	5	10	20	32	50
■ Static Evaporation Rate* L/day	0.19	0.15	0.18	0.18	0.22	0.49
Unit Dimensions						
■ Neck Opening in. (mm)	1.40 (35)	2.18 (56)	2.18 (56)	2.18 (56)	2.50 (64)	2.50 (64)
■ Useable Height in. (mm)	7.8 (198)	10.5 (266)	13.5 (343)	13.7 (348)	14.9 (378)	22.0 (559)
■ Overall Height in. (mm)	16.8 (426)	18.2 (462)	21.5 (546)	24.5 (622)	24.0 (610)	30.5 (775)
■ Outer Diameter in. (mm)	7.3 (185)	8.8 (222)	10.3 (260)	14.5 (368)	17.0 (432)	17.0 (432)
■ Internal Diameter in. (mm)	5.5 (139)	6.5 (165)	8.3 (210)	11.4 (289)	14.0 (356)	14.0 (356)
■ Weight Empty lb. (kg)	6 (2.7)	8 (4)	12 (5.4)	19 (9)	25 (11.4)	31 (14)
■ Weight Full lb. (kg)	13 (6)	17 (8)	31 (14)	55 (25)	82 (37.2)	120 (54.4)

MVE Lab Series Liquid Dewars

Cat. No.	Model Number/Description	List Price	Cat. No.	Model Number/Description	List Price
9922219	Lab 4 Unit, 4L Capacity	\$ 989.00	9711929	Pouring Spout for Lab 30 and Lab 50	\$268.00
9918079	Lab 5 Unit, 5L Capacity	\$ 894.00	10668101	Manual Discharge Device for Lab 10	\$976.00
10740281	Lab 10 Unit, 10L Capacity	\$ 943.00	13484139	Manual Discharge Device for Lab 20	\$971.00
13492631	Lab 20 Unit, 20L Capacity	\$1,223.00	10668004	Manual Discharge Device for Lab 30	\$971.00
9918099	Lab 30 Unit, 30L Capacity	\$1,450.00	10668021	Manual Discharge Device for Lab 50	\$971.00
9918109	Lab 50 unit, 50L Capacity	\$1,973.00	10937391	Roller Base for Lab 20	\$ 415.00
9720729	Pouring Spout for Lab 5, Lab 10 and Lab 20	\$ 268.00	10937403	Roller Base for Lab 30 or Lab 50	\$ 415.00

MVE Doble Series

- Charge the absorbent layer in base of tank to use Doble as vapor shipper
- Fill with LN₂ for long-term sample storage
- Use with protective shipping containers to ensure upright transport
- Straw or vial shipping and storage
- 2 year parts, 3 year vacuum warranty
- Liquid and Vapor Storage Options Available



MVE Doble Series							
	Doble 11	Doble 20	Doble 22	Doble 28	Doble 34	Doble 47-6	Doble 47-10
Maximum Storage Capacity							
■ Number of Canisters	6	6	6	6	6	6	10
■ No. of 1/2 cc Straws 10/cane	660	660	2400	2,400	2,100	4,500	3,500
■ Vial Capacity	210	210	810	810	630	1,320	1,050
■ LN ₂ Capacity w/o Inventory L est.	10.0	18.5	20.0	28.0	32.0	46.0	46.0
■ Vapor Capacity L	3.1	4.2	5.5	8.4	7.9	6.0	6.0
■ Static Evaporation Rate L/day	0.17	0.10	0.35	0.35	0.20	0.40	0.40
■ Working Duration days for liquid	37	116	40	50	110	74	72
■ Working Duration days for vapor	17	21	18	21	21	21	21
Unit Dimensions							
■ Neck Opening in (mm)	2.18 (55)	2.18 (55)	3.81 (97)	3.81 (97)	3.50 (89)	5.00 (127)	5.00 (127)
■ Overall Height in (mm)	21.6 (549)	25.5 (647)	22 (559)	22 (559)	26.6 (676)	26.5 (673)	26.5 (673)
■ Outside Diameter in (mm)	10.2 (260)	14.5 (368)	14.5 (368)	18.2 (462)	18.2 (462)	20.0 (508)	20.0 (508)
■ Canister Height in (mm)	11 (279)	11 (279)	11 (279)	11 (279)	11 (279)	11 (279)	11 (279)
■ Canister Diameter in (mm)	1.65 (42)	1.65 (42)	3.09 (79)	3.09 (79)	2.81 (72)	4.00 (101)	2.81 (72)
■ Weight Empty lb. (kg)	14.5 (6.6)	23 (10.4)	23.8 (10.7)	33 (15.0)	34.5 (15.6)	41 (18.5)	41 (18.5)
■ Weight Charged vapor lb. (kg)	19.5 (8.8)	30.3 (13.7)	35 (15.8)	47 (21.3)	47.9 (21.7)	54.6 (24.7)	54.6 (24.7)
■ Weight Full liquid lb. (kg)	32 (14.5)	56 (25.4)	68 (30.8)	89 (40.4)	92 (41.7)	117 (53.1)	117 (53.1)
■ Protective Shipping Container Part No.	20750519	11912460	20750520	11930861	20863878	14035731	14035731

MVE Doble Series		
Cat. No.	Model Number/Description	List Price
11507886	Doble 11 with (6) 11" Canisters	\$1,519.00
20750519	Doble 11 Protective Shipping Container	\$ 609.00
11492151	Doble 20 with (6) 11" Canisters	\$1,530.00
11912460	Doble 20 Protective Shipping Container	\$ 774.00
20937586	Doble 22 with (6) 11" Canisters	\$2,362.00
20750520	Doble 22 Protective Shipping Container	\$ 774.00
10937391	Doble 22 Roller Base	\$ 415.00

MVE Doble Series		
Cat. No.	Model Number/Description	List Price
11527730	Doble 28 with (6) 11" Canisters	\$2,502.00
11930861	Doble 28 Protective Shipping Container	\$ 965.00
11497948	Doble 34 with (6) 11" canisters	\$2,154.00
20863878	Doble 34 Protective Shipping Container	\$ 924.00
11498684	Doble 47-6 with (6) 11" Canisters	\$2,788.00
11554308	Doble 47-10 with (10) 11" Canisters	\$2,808.00
14035731	Doble 47-6 and 47-10 Protective Shipping Container	\$ 924.00

MVE Vapor Shipper Series

- Charge the absorbent layer in base of tank for dry sample shipping
- Use with protective shipping containers to ensure upright transport
- 1/4 and 1/2cc straws, blood bag or vial shipping
- 2 year parts, 3 year vacuum warranty



MVE Vapor Shipper Series	SC 2/1V	SC 4/2V	SC 4/3V	XC 30/12V	Cryo-Shipper	VERY POPULAR Cryo-Shipper XC	VERY POPULAR CryoShipper 2000	IATA	65/5V
Maximum Storage Capacity									
■ No. of Canisters	1	1	1	1	1 Rack	—	4 square racks	Stainless Steel Secondary Container Dimensions: 7-3/8" diameter 8-3/4" deep	1x 5/2 vial box rack (100 vials/box)
■ No. of 1/2 cc Straws 10/cane	—	280	120	60		—	5 boxes per rack 2,000 total 1.2mL & 2.0mL vials (100/box)		
■ No. of 1/2 cc Straws 1 Level Bulk	88	44	210	312		—			
■ No. of 1/4 cc Straws 1 Level Bulk	182	938	452	660		—			
■ No. of 1.2 & 2.0 ml Vials 5/cane	—	95	40	30	500	966 (Bulk)			
■ No. of 1.2 & 2.0 ml Vials 6/cane	—	102	48	36					
■ No. of blood bags stored 4R9953	—	—	—	—	10	10			
Performance (Hold Time overrides NER specifications)									
■ LN ₂ Capacity L	1.5	3.6	4.3	18	8.5	10.0	65	10.0	27.4
■ Static Holding Time Days	8	13	21	82	10	14	15	14	40
■ Static Evaporation Rate L/day	0.19	0.26	0.20	0.22	0.85	0.70	.79	0.70	0.79
Unit Dimensions									
■ Neck Opening in. (mm)	1.40 (35.0)	2.75 (70.0)	2.00 (51.0)	2.00 (51.0)	8.50 (216.0)	8.50 (216.0)	8.5 (216)	8.50 (216.0)	8.50 (216.0)
■ Overall Height in. (mm)	13.5 (343)	18.4 (468)	19.4 (492)	24.3 (617)	21.5 (546)	23.0 (584)	27.2 (692)	23.0 (584)	27.3 (694)
■ Outer Diameter in. (mm)	7.25 (184)	8.70 (222)	8.70 (222)	17.0 (432)	14.50 (369)	15.00 (381)	22.0 (559)	15.00 (381)	22 (559)
■ Canister Height in. (mm)	5.0 (127)	11.0 (279)	11.0 (279)	11 (279)	11.0 (279)	12.5 (317.5)	—	8.75 (222.25)	—
■ Canister Diameter in. (mm)	1.20 (31)	2.62 (67)	1.81 (46)	1.96 (50)	5.6 (142) x 6.6 (167)	8.5 (216)	—	7.375 (187.325)	—
■ Weight Empty lb. (kg)	6.0 (2.7)	10.0 (4.5)	11.6 (5.3)	44 (20)	26.1 (11.8)	33.0 (15.0)	65 (29.5)	33.0 (15.0)	74.5 (33.9)
■ Weight Charged lb. (kg)	8.0 (3.6)	17.1 (7.7)	19.1 (8.7)	76 (34)	39.0 (17.7)	49.0 (22.2)	95 (43.1)	49.0 (22.2)	145.5 (66.2)
■ Weight Full lb. (kg)	9.0 (4.1)	20.0 (9.1)	21.0 (9.5)	82 (37.2)	54.5 (24.7)	73.0 (33.1)	185 (83.9)	73.0 (33.1)	185 (83.9)
■ Protective Shipping Container Part No.	20750408 \$557.00	20750409 \$557.00	20750409 \$557.00	21325842 \$893.00	20750520 \$624.00	10741726 \$897.00	12875162 \$960.00	10741726 \$897.00	12875162 \$960.00

MVE Vapor Shipper Series			MVE Vapor Shipper Series		
Cat. No.	Model Number/Description	List Price	Cat. No.	Model Number/Description	List Price
9922339	SC2/1 V with (1) 5" (127mm) Canister	\$1,444.00	10777411	IATA Cryoshipper includes Cryoshipper XC, secondary container and shipping container with labeling	\$6,263.00
9918479	SC4/2 V with (1) 11" (279mm) Canister	\$1,484.00			
10817330	SC4/3 V with (1) 11" (279mm) Canister	\$1,516.00			
21244576	XC30/12V with (1) 11" (279mm) Canister	\$2,694.00			
11366673	Cryoshipper 2000	\$4,357.00	21532115	Data Logger Lid Assemblies installed on dewar cork and cover: Cryoshipper XC; Cryoshipper	\$2,249.00
10508967	Cryoshipper w/Blood Bag Rack (w/shipping container)	\$4,391.00	21553216S	Data Logger Lid Assemblies installed on dewar cork and cover: SC 4 / 2 V	\$2,212.00
20925284	Cryoshipper w/5-2 SQ Rack (w/shipping container)	\$4,391.00	21553217S	Data Logger Lid Assemblies installed on dewar cork and cover: SC 4 / 3 V	\$2,212.00
11015195	Cryoshipper Extra Capacity (XC) w/o rack (w/shipping container)	\$4,356.00			



MVE CryoCube™ and BL-7

- One-way cryogenic shipping
- Operates as a dry shipper
- Ship in any orientation – doesn't have to be upright!
- Save on dry ice, packaging, shipping and disposal costs
- One year vacuum warranty



MVE Blood Bag Shippers

- Safe for international shipping: IATA dangerous goods regulations exempt
- Two year vacuum warranty

MVE Blood Bag Shippers		
	CT-50	CT-250
Maximum Storage Capacity		
■ Number of Blood Bags	2 (25 mL)	2 (250 mL)
■ LN ₂ Capacity w/o Inventory L est.	5	8
■ Static Evaporation Rate* L/day	0.5	0.8
■ Static Holding Time* days	10	10
Unit Dimensions		
■ Neck Opening in. (mm)	3.82 (97)	6.5 (165)
■ Overall Height in. (mm)	15 (380)	19.8 (502)
■ Outer Diameter/Width in. (mm)	14.5 (368)	16.0 (406)
■ Weight Empty lb. (kg)	17.6 (8)	24.3 (11)
■ Weight Charged vapor lb. (kg)	26.45 (12)	38.6 (17.5)

MVE CryoCube™ & BL-7		
	MVE CryoCube™	MVE BL-7
Maximum Storage Capacity		
■ Number of Canisters	1	1
■ Number of 1/2 cc Straws 1 Level Bulk	182	270
■ LN ₂ Capacity w/o Inventory L est.	1.5	2.1
■ Static Holding Time* days	5	7
Unit Dimensions		
■ Neck Opening in. (mm)	1.4 (35)	1.97 (50)
■ Overall Height in. (mm)	12.5 (317.5)	15.0 (381)
■ Overall Width in. (mm)	12 (305)	12.64 (321)
■ Overall Diameter in. (mm)	1.25 (32)	1.50 (38)
■ Weight Empty lb. (kg)	7.5 (3.41)	9.26 (4.2)
■ Weight Charged vapor lb. (kg)	10.2 (4.63)	13.01 (5.9)

MVE CryoCube™ & BL-7		
Cat. No.	Model Number/Description	List Price
20902359	Cryocube Shipper	\$239.00
20860675	BL7 Cryocube	\$278.00

MVE Blood Bag Shippers		
Cat. No.	Model Number/Description	List Price
21007700	CT50 CryoShipper	\$1,147.00
21166073	CT50 Shipping Container with box	\$ 590.00
21116533	CT50 Standard Equipment Frame/ Cassette Puller (open ends)	\$ 38.00
21000341	CT250 CryoShipper	\$1,551.00
21000341	CT250 Shipping Container with box	\$ 633.00
21003575	CT250 Standard Equipment Frame/ Cassette Puller	\$ 40.00

Isothermal Cryogenic Dry-Vapor Freezers

- Engineered to maximize sample integrity
- Technology includes a LN₂ filled jacket that surrounds the chamber to provide completely dry storage and temperature consistency throughout the chamber
- Liquid-free chamber reduces chance of cross contamination
- No LN₂ in the chamber means minimal temperature decrease with lid open
- SmartTouch Controller features dual temperature display, autofill, alarm, fill timer, exportable reports, Modbus enabled, and programmable lid alarm
- 2 year parts, 5 year vacuum warranty

Cutting Edge Jacket Technology provides MORE space!



Isothermal Cryogenic Dry-Vapor Freezers

	V-1500AB	V-3000AB	V-5000AB	V-3000ABEH	V-5000ABEH	V-3000AB/C	V-5000AB/C	V-3000ABEH/C	V-5000ABEH/C
LN₂ Capacity									
	30 Liters	70 Liters	93 Liters	89 Liters	140 Liters	70 Liters	93 Liters	89 Liters	140 Liters
Maximum Storage Capacity									
■ Vials (2 mL)	9,100	22,100	40,300	25,500	46,500	16,800	36,400	21,000	42,000
■ Cryobags (50 mL)	434	1,120	1,936	1,280	2,208	792	1,638	1,056	1,872
Unit Dimensions									
■ External Length mm (in.)	1005.8 (39.6)	1277.6 (50.3)	1450.3 (57.1)	1277.6 (50.3)	1450.3 (57.1)	1259.8 (49.6)	1445.3 (56.9)	1259.8 (49.6)	1445.3 (56.9)
■ External Width mm (in.)	675.6 (26.6)	955 (37.6)	1371.6 (54)	955 (37.6)	1371.6 (54)	970.3 (38.2)	1191.3 (46.9)	970.3 (38.2)	1191.3 (46.9)
■ Usable Interior Diameter mm (in.)	533.4 (21)	787.4 (31)	1016 (40)	787.4 (31)	1016 (40)	736.6 (29)	965.2 (38)	736.6 (29)	965.2 (38)
■ External Height mm (in.)	1211.6 (47.7)	1249.7 (49.2)	1430 (56.3)	1463 (57.6)	1551.9 (61.1)	1292.9 (50.9)	1475.7 (58.1)	1582.4 (62.3)	1602.7 (63.1)
■ Usable Interior Height mm (in.)	736.6 (29)	736.6 (29)	736.6 (29)	939.8 (37)	863.6 (34)	685.8 (27)	736.6 (29)	914.4 (36)	863.6 (34)
■ Liftover Height mm (in.)	1965.9 (77.4)	2278.4 (89.7)	2578.1 (101.5)	2491.7 (98.1)	2700 (106.3)	—	—	—	—

Dry Vapor Cryogenic Freezers

Isothermal Cryogenic Dry-Vapor Freezers

Cat. No.	Model Number/Description	List Price
V-Series Full Lip Opening		
55156V-ST	Model V-1500AB Isothermal Freezer, including Series 2301 SmartTouch Controller Autofill-Monitor System with Gas By-Pass System and LN ₂ Hose	\$22,687.94
55305V-ST	Model V-3000AB Isothermal Freezer, including Series 2301 SmartTouch Controller Autofill-Monitor System with Gas By-Pass System and LN ₂ Hose	\$41,063.34
55505V-ST	Model V-5000AB Isothermal Freezer, including Series 2301 SmartTouch Controller Autofill-Monitor System with Gas By-Pass System and LN ₂ Hose	\$48,146.86
55305VEH-ST	Model V-3000ABEH Isothermal Freezer, including Series 2301 SmartTouch Controller Autofill-Monitor System with Gas By-Pass System and LN ₂ Hose (Extended Height)	\$41,739.10
55505VEH-ST	Model V-5000ABEH Isothermal Freezer, including Series 2301 SmartTouch Controller Autofill-Monitor System with Gas By-Pass System and LN ₂ Hose (Extended Height)	\$49,861.55
V-Series Carousel Vapor Models		
77301C-ST	Model V-3000AB/C Isothermal Carousel Freezer, including Series 2301 ST (Smart-Touch Controller) Autofill-Monitor System with Gas By-Pass System, Carousel, Step and LN ₂ Hose	\$41,951.94
77501C-ST	Model V-5000AB/C Isothermal Carousel Freezer, including Series 2301 ST (Smart-Touch Controller) Autofill-Monitor System with Gas By-Pass System, Carousel, Step and LN ₂ Hose	\$50,066.97
77302CEH-ST	Model V-3000ABEH/C Isothermal Carousel Freezer, including Series 2301 ST (Smart-Touch Controller) Autofill-Monitor System with Gas By-Pass System, Carousel, Step and LN ₂ Hose (Extended Height)	\$43,342.15
77502CEH-ST	Model V-5000ABEH/C Isothermal Carousel Freezer Including Series 2301 ST (Smart-Touch Controller) Autofill-Monitor System with Gas By-Pass System, Carousel, Step and LN ₂ Hose (Extended Height)	\$51,251.77



Isothermal Carousel model with square lid

A wide lid opening allows easy access to all racks, and provides an extensive variety of inventory solutions.

Cryogenic Liquid Phase Freezers - Standard Series

- All S series freezers use the 2301 Controller with autofill functionality and dual temperature probes
- Flexibility for vapor storage, immersion storage, or a combination of both
- Round, space saving design
- Wide lid opening for easy access to racks
- Stainless steel, vacuum insulated vessel
- Woven lid gasket design and counter-balanced lockable lid
- Castor mounted
- Accommodates square, vertical and mini racks; canister and frame systems; vials, boxes, canisters / cassettes and platform dividers
- 2 year parts, 5 year vacuum warranty



Cryogenic Liquid Phase Freezers - Standard Series				
	S-1500AB	S-3000AB	S-5000AB	S-5000ABEH
LN₂ Capacity	145 Liters	345 Liters	615 Liters	720 Liters
Maximum Storage Capacity				
■ Vials (2 mL)	9,100	22,100	40,300	46,500
■ Blood Bags (50 mL)	434	1,120	720	2,208

Cryogenic Liquid Phase Freezers - Standard Series		
Cat. No.	Model Number/Description	List Price
33156	Model S-1500AB, Standard LN ₂ Container, including 2301 Autofill-Monitor System with Gas By-Pass and LN ₂ Hose	\$16,433.83
33305	Model S-3000AB, Standard LN ₂ Container, including 2301 Autofill-Monitor System with Gas By-Pass and LN ₂ Hose	\$29,504.80
33505	Model S-5000AB, Standard LN ₂ Container, including 2301 Autofill-Monitor System with Gas By-Pass and LN ₂ Hose	\$35,511.52
33505BEH	Model S-5000ABEH, Standard LN ₂ Container, including 2301 Autofill-Monitor System with Gas By-Pass and LN ₂ Hose. (Extended Height)	\$36,904.60

Did you know LabMart can provide text or matching 1D/2D barcoded vials? We can help your lab's tracking and on-demand needs with our IDs. Permanent custom barcoding is also available. 100% quality control ensures that all high-quality standards are met!

**Need help identifying your requirements?
Call us today for assistance.**

Model 2101

- Laptop controller using Windows based operating system
- Unlimited programming capability
- Multi-color graphing of sample, chamber and program temperature
- Temperature set points by sample or chamber
- Programs and freeze data saved to hard drive or disc
- Password protected software
- Searchable database for freeze run history
- Freeze run graphs and data available via any standard USB printer
- 30 data fields available for each freeze run
- Continuous digital and graph display for time and temperature during operation
- Manual overrides for all operating functions
- Temperature range +50°C to -180°C
- Freezing rates of 0.01° to 99.9° per minute
- Program temperature hold of 1 second to 99 hours
- Six pre-set easy to run freeze programs
- 1 year warranty



Controlled Rate Cryogenic Freezers (CRF) - Model 2101

Power Requirements

120 volt, 50/60 Hz, 10 amp or 230 volt, 50/60 Hz, 10 amp

Outside Dimensions

Depth	25 1/2" (648 mm) (including vent)
Height	29 1/4" (743 mm) (including computer)
Width	19 1/16" (484 mm) (including hose connection)

Inside Dimensions

Depth	9 9/16" (243 mm)
Height	13 3/4" (349 mm)
Width	14" (356 mm)

28 Liters

Controlled Rate Cryogenic Freezers (CRF) - Model 2101

Cat. No.	Model Number/Description	List Price
42100	Controlled Rate Freezing System, including Laptop Computer with 2101 Software with Freezing Chamber, Mobile Cart, 4 Foot LN ₂ Hose and Sample Freezing Rack and Single Probe	\$29,134.14
42101	Controlled Rate Freezing System, including Laptop Computer with 2101 Software, Freezing Chamber, 4 Foot LN ₂ Hose and Limited Choice of Sample Freezing Racks and Single Probe	\$27,677.44
3120-F601	Optional Roller Cart for 2101 Controlled Rate Freezing System	\$ 2,507.84
42100-EQ	Controlled Rate Freezing System, including Laptop Computer with 2101 Software with 2 Equine Freezing Profiles, Freezing Chamber, Mobile Cart, 4 Foot LN ₂ Hose and Sample Freezing Rack and Single Probe	\$29,134.14
42101-EQ	Controlled Rate Freezing System, including Laptop Computer with 2101 Software with 2 Equine Freezing Profiles, Freezing Chamber, Mobile Cart, 4 Foot LN ₂ Hose and Sample Freezing Rack and Single Probe	\$27,677.44
42100-MPI	Controlled Rate Freezing System, Multi-Probe, including Laptop Computer with 2101 Software, Freezing Chamber, Mobile Cart, 4 Foot LN ₂ Hose and Limited Choice of Sample Freezing Rack and Single Probe	\$34,275.46
42101-MPI	Controlled Rate Freezing System, Multi-Probe, including Laptop Computer with 2101 Software, Freezing Chamber, 4 Foot LN ₂ Hose and Limited Choice of Sample Freezing Rack and Single Probe	\$32,561.69

Model IntelliRate™ i67C

- Sized to scale precision rate freezing as your needs grow
- With 40% more capacity than other benchtop CRFs, the IntelliRate i67C can increase production levels, while ensuring more process consistency and time savings by running thousands of samples in a single run
- 1 year warranty

Model IntelliRate™ i67C Controlled Rate Freezers

Flexible Power Requirements

120-volt, 50/60 Hz, 10 amp or 240-volt, 50/60 Hz, 10 amp

More Freeze Capacity

67-liter (2.35 cu. ft.) volume inside the chamber delivers more batch capacity to freeze:

- 104 50mL bags • 2166 2mL vials • 100 cassettes
- 26 1-liter bags • 272 canes

Programming and Control Features

- Six preset programs with unlimited variations
- Repeatable temperature rate changes within cycles
- Programmable temperature range of -180°C to +50°C
- Freeze rates of 0.01 to 99.9°C per minute
- 21 CRF Part 11 compliant reporting protocols



INTERIOR VIEW
67-liter (2.35 cu. ft.)
volume inside the chamber

Model IntelliRate™ i67C Controlled Rate Freezers

Cat. No.	Model Number/Description	List Price
42101-67	The IntelliRate i67C Controlled Rate Freezer, 120V. Includes a built-in touchscreen controller with a stylist pen and 2101 Software with unlimited programming capability. Also included with the freezer are accessories including a 6-Foot LN2 Hose and a Single Probe for temperature monitoring in the chamber	\$36,380.00
42101-67-MPI	The IntelliRate i67C Controlled Rate Freezer, 120V. Includes a built-in touchscreen controller with a stylist pen and 2101 Software. Also included with the freezer are accessories including a 6-foot LN2 Hose and Multiple Probes for temperature monitoring throughout the chamber	\$40,660.00
42101-67-240V	The IntelliRate i67C Controlled Rate Freezer, 240V. Includes a built-in touchscreen controller with a stylist pen and 2101 Software with unlimited programming capability. Also included with the freezer are accessories including a 6-Foot LN2 Hose and a Single Probe for temperature monitoring in the chamber	\$36,380.00
42101-67-240V-MPI	The IntelliRate i67C Controlled Rate Freezer, 240V. Includes a built-in touchscreen controller with a stylist pen and 2101 Software. Also included with the freezer are accessories including a 6-foot LN2 Hose and Multiple Probes for temperature monitoring throughout the chamber	\$40,660.00

As cell-based research and bioproduction volumes increase, you need a repeatable freezing process that can efficiently improve post-thaw viability rates and cryopreservation quality at scale.

The IntelliRate™ i67C increases single-batch, liquid nitrogen (LN2) CRF capabilities to meet your needs as development and manufacturing volumes increase.

Value Added Cryosystems

- Lockable lids
- Low liquid nitrogen consumption
- Lightweight aluminum construction and low space demands
- Easy access to store or retrieve samples
- Square racks with boxes and dividers
- 3 year vacuum warranty
- Aluminum options: built in CRYO-LA, CRYO-BAT



Value Added Cryosystems		
Cat. No.	Model Number/Description	List Price
Series 2001 Value Added Cryosystem		
CB201	Cryosystem 2000 Rack, 5-Shelf, for 2-Inch High Boxes, Stainless Steel, with Locking Rod	\$6,481.91
CB201R	Cryosystem 2000 Rack, 5-Shelf, for 2-Inch High Boxes, Roller Base, Stainless Steel, with Locking Rod	\$6,788.08
CB201B	Cryosystem 2000 Rack, 5-Shelf, for 2-Inch High Boxes, Roller Base, Battery Alarm, Stainless Steel, with Locking Rod	\$7,658.31
CB201L	Cryosystem 2000 Rack, 5-Shelf, for 2-Inch High Boxes, Roller Base, 110v Alarm, Stainless Steel, with Locking Rod	\$7,764.50
Series 4001 Value Added Cryosystem		
CB401	Cryosystem 2000 Rack, 10-Shelf, for 2-Inch High Boxes, Stainless Steel, with Locking Rod	\$6,597.77
CB401R	Cryosystem 2000 Rack, 10-Shelf, for 2-Inch High Boxes, Roller Base, Stainless Steel, with Locking Rod	\$6,901.18
Series 6001 Value Added Cryosystem		
CB601	Cryosystem 2000 Rack, 10-Shelf, for 2-Inch High Boxes, Stainless Steel, with Locking Rod	\$7,178.37
CB601R	Cryosystem 2000 Rack, 10-Shelf, for 2-Inch High Boxes, Roller Base, Stainless Steel, with Locking Rod	\$7,512.13
CB601B	Cryosystem 2000 Rack, 10-Shelf, for 2-Inch High Boxes, Roller Base, Battery Alarm, Stainless Steel, with Locking Rod	\$8,383.74
CB601L	Cryosystem 2000 Rack, 10-Shelf, for 2-Inch High Boxes, Roller Base, 110v Alarm, Stainless Steel, with Locking Rod	\$8,494.07

Value Added Cryosystems			
	2001 Value Added	4001 Value Added	6001 Value Added
Storage Capacity			
■ Maximum number of racks	4	4	6
■ Maximum boxes per rack	5	10	10
■ Number of 1.2 and 2mL vials - 100/box	2,000	4,000	6,000
Liquid Nitrogen Usage and Capacities			
■ Liquid nitrogen capacity (liters)	61	121	175
■ Static evaporation rate (liters per day)	0.85	0.99	0.99
■ Working volume (liters)	51	111	165
■ Normal working days	38	70	104
Dimensions			
■ Neck opening in. (mm)	8.5 (216)	8.5 (216)	8.5 (216)
■ Overall height in. (mm)	28.5 (723)	39.5 (1,003)	39.5 (1,003)
■ Outside diameter in. (mm)	22 (559)	22 (559)	26 (665)
■ Weight empty lbs. (kgs)	58 (26.3)	81 (36.7)	103 (46.7)
■ Weight full lbs. (kgs)	182 (82.5)	300 (136)	425 (193)

Aluminum Canisters and Frames for Blood Bags

- Constructed of lightweight Aluminum
- Canisters hold Baxter Fenwal, Chartmed, Gambo, Stericon, Medsep, and Origen Blood Bags
- Canister sizes: 50mL, 250mL*
- Canisters have locking handle and thumb hole
- Canister frames include handles*
- Lifetime warranty for aluminum canisters and frames



C-50
50mL Blood Bag Canister

Aluminum Canisters and Frames for Blood Bags						
Cat. No.	Product Name	Blood Bag Number	Description	Dimensions in (mm)	Frame	List Price
C-50	50 mL Blood Bag Canister	Fenwal 4R9951, Origen CS50, CryoMACS 200-074-400, CharterMed CF-50, FP-50ML and FP-FLEX50	Holds most 50mL Blood Bags	6.30"D x 0.46"W x 3.62"H (160mmD x 11.8mmW x 92mmH)	F-C-50-7 F-C-50-8 F-C-50-9	\$36.25
C-250	250 mL Blood Bag Canister	Baxter Fenwal 4R9953, Origen CS250, CryoMACS 200-074-401, CharterMed CF-250, FP-250ML	Holds most 250mL Blood Bags	7.52"D x 0.46"W x 6.00"H (191mmD x 11.8mmW x 152.5mmH)	F-C-250-3 F-C-250-4 F-C-250-5	\$36.25
Cat. No.	Product Name	Blood Bag Number	Description	Dimensions in (mm)	Canisters	List Price
F-C-50-7	7-High Frame for C-50	Fenwal 4R9951, Origen CS50, CryoMACS 200-074-400, CharterMed CF-50, FP-50ML, FP-FLEX50	Holds 7 C-50 Canisters	5.71"D x 0.59"W x 26.06"H (145mmD x 15mmW x 662mmH)	C-50	\$48.32
F-C-50-8	8-High Frame for C-50	Fenwal 4R9951, Origen CS50, CryoMACS 200-074-400, CharterMed CF-50, FP-50ML, FP-FLEX50	Holds 8 C-50 Canisters	5.71"D x 0.59"W x 29.72"H (145mmD x 15mmW x 755mmH)	C-50	\$64.47
F-C-250-4	4-High Frame for C-250	Baxter Fenwal 4R9953, Origen CS250, CryoMACS 200-074-401, CharterMed CF-250, FP-250ML	Holds 4 C-250 Canisters	6.93"D x 0.59"W x 24.92"H (176mmD x 15mmW x 633mmH)	C-250	\$53.17



F-C-50-7
7-High Frame For C-50

* Canister and Frames also available in 500mL, 750mL and 100mL — call for prices

Frames for Blood and Bone Marrow - LTI Inventory Control Systems

- Popular for plasma, cord blood and bone marrow storage
- Stainless steel frames are welded for superior durability
- Baxter 9955/9957 AKA 62/63, 2111 and canisters also available

Made in  the USA

Plasma System Frames						
Cat. No.			Dimensions H x W x T			List Price
61F-4SC	Baxter 9953 AKA 61	4 PLC	32.25"	6.5"	.60"	\$57.00
61F-5SC		5 PLC	26"	6.5"	.60"	\$60.00
61F-6SC		6 PLC	19.75"	6.5"	.60"	\$67.00
51F-6SC	Baxter 9951 AKA 51	6 PLC	25"	5.5"	.60"	\$59.00
51F-75C		7 PLC	29"	5.5"	.60"	\$62.00
51F-8SC		8 PLC	33"	5.5"	.60"	\$68.00
52F-6SC	Medsep AKA 52	6 PLC	23.25"	3 5/16"	.56"	\$58.00
52F-75C		7 PLC	27"	3 5/16"	.56"	\$61.00
52F-8SC		8 PLC	30.75"	3 5/16"	.56"	\$68.00

Liquid Nitrogen Freezer Rack with Locking Rod

Made in the USA 

- Corrosion resistant stainless steel
- All individual racks are shipped without boxes
- Boxes sold separately



Liquid Nitrogen Freezer Rack with Locking Rod			
Cat. No.	Capacity	Dimensions	List Price
Large Liquid Nitrogen Freezer Rack with Locking Rod			
SR 8-3	Holds (15) 2" Boxes	5.50" x 5.50" x 25.30"	\$126.51
SR 9-3	Holds (9) 3" Boxes	5.50" x 5.50" x 28.56"	\$115.44
SR 10-2	Holds (10) 2" Boxes	5.50" x 5.50" x 22.13"	\$109.98
SR 11-2	Holds (11) 2" Boxes	5.50" x 5.50" x 24.20"	\$111.72
SR 12-2	Holds (12) 2" Boxes	5.50" x 5.50" x 26.50"	\$123.56
SR 13-2	Holds (13) 2" Boxes	MOST POPULAR! 5.50" x 5.50" x 28.60"	\$130.58
SR 14-2	Holds (14) 2" Boxes	5.50" x 5.50" x 30.75"	\$142.84
SR 15-2	Holds (15) 2" Boxes	5.50" x 5.50" x 32.88"	\$155.65
Mini Liquid Nitrogen Freezer Rack with Locking Rod			
MR12-2-Mini	Holds (12) 2" Mini Plastic Boxes	3.38" x 3.15" x 26.50"	\$105.64
MR13-2-Mini	Holds (13) 2" Mini Plastic Boxes	3.38" x 3.15" x 28.60"	\$103.32
MR14-2 Mini	Holds (14) 2" Mini Plastic Boxes	3.38" x 3.15" x 30.75"	\$126.85
SR15-2-Mini	Holds (15) 2" Mini Plastic Boxes	3.38" x 3.15" x 32.88"	\$135.85

The LabMart Distribution Companies offer a full line of Laboratory Supplies, Equipment and Chemicals from well-known brands, and our own LabMart Brand portfolio of quality products at competitive prices to fit all laboratory budgets.

Please consult your institutional pricing for current discounted prices.

Cryo-Gloves

Wrist Length, Water Proof, Breathable and Stay Dry Lining, 1 Pair					
	Small	Medium	Large	Extra-large	List Price
Blue	WRSWP	WRMWP	WRLWP	WRXLWP	\$223.36
Pink	P-RWS	P-RWM	P-RWL	P-RWXL	\$215.07
Mid-Arm Length, Water Proof, Breathable and Stay Dry Lining, 1 Pair					
	Small	Medium	Large	Extra-large	List Price
Blue	MAS	MAM	MAL	MAXL	\$283.44
Pink	P-MAS	P-MAM	P-MAL	P-MAXL	\$237.21
Elbow Length, Water Proof, Breathable and Stay Dry Lining, 1 Pair					
	Small	Medium	Large	Extra-large	List Price
Blue	EBSWP	EBMWP	EBLWP	EBXLWP	\$312.23
Pink	P-EBS	P-EBM	P-EBL	P-EBXL	\$298.21



Face and Eye Protection

Cat. No.	Description	List Price
PAT794	Protective Cryo Goggles	\$ 44.67
FSH1001	Cryo-Protection Face Shield Headgear with adjustable headband, clear large replaceable splash guard, adjustable pivots, clear window measures 10" x 10" x .060"	\$116.65



Cryo Aprons

Cat. No.	Description	List Price
CA36	Cryo-Apron, Water Proof, Splash Protection, Breathable, Quick Release Buckles at Neck and Waist, Maximum Thermal Protection, Light Weight and Comfortable, 36" Length	\$222.10
CA42	Cryo-Apron, Water Proof, Splash Protection, Breathable, Quick Release Buckles at Neck and Waist, Maximum Thermal Protection, Light Weight and Comfortable, 42" Length	\$234.03
CA48	Cryo-Apron, Water Proof, Splash Protection, Breathable, Quick Release Buckles at Neck and Waist, Maximum Thermal Protection, Light Weight and Comfortable, 48" Length	\$240.63
CA54	Cryo-Apron, Water Proof, Splash Protection, Breathable, Quick Release Buckles at Neck and Waist, Maximum Thermal Protection, Light Weight and Comfortable, 54" Length	\$265.31
10464394	Cryogenic Apron, Full Length	\$506.00



Cryo Tools

Cat. No.	Description	List Price
LMS-36	Measuring Stick, Liquid Level (Measures up to 36"/92 Centimeters)	\$ 25.95
C-4	Cryomarker - Set of 4 Pens (Black, Blue, Green & Red) Recommended for all Cryovials at -200°C	\$ 38.33
C-12	Cryomarker - Set of 12 Pens, One Color per Box (Specify Color - Black, Blue, Green or Red)	\$ 82.66
AR101	Sample Retrieval Device - Small (3" x 3")	\$390.56
AR102	Sample Retrieval Device - Large (6" x 6")	\$398.70
13051579	Cool Reach - Retrieval Tool - 40" (includes handle)	\$286.00

BIOX

Cryogenic Vials

BioX Barcoded Cryovials 1D

- Clear polypropylene
- Sterile pre-set 1D barcoded with external thread and caps assembled
- Writing patch and marked graduations
- 25 cryovials/bag, 20 bags/pack, 2 packs/case, price/case/1000

BIOX Barcoded Cryovials 1D

Cat. No.	Description	List Price
BX88-6050	0.5mL Sterile Pre-set 1D Barcoded Cryovials, White Caps	\$240.40
BX88-6051	0.5mL Sterile Pre-set 1D Barcoded Cryovials, Red Caps	\$240.40
BX88-6052	0.5mL Sterile Pre-set 1D Barcoded Cryovials, Green Caps	\$240.40
BX88-6053	0.5mL Sterile Pre-set 1D Barcoded Cryovials, Blue Caps	\$240.40
BX88-6054	0.5mL Sterile Pre-set 1D Barcoded Cryovials, Yellow Caps	\$240.40
BX88-6055	0.5mL Sterile Pre-set 1D Barcoded Cryovials, Purple Caps	\$240.40
BX88-6100	1.0mL Sterile Pre-set 1D Barcoded Cryovials, White Caps	\$240.40
BX88-6101	1.0mL Sterile Pre-set 1D Barcoded Cryovials, Red Caps	\$240.40
BX88-6102	1.0mL Sterile Pre-set 1D Barcoded Cryovials, Green Caps	\$240.40
BX88-6103	1.0mL Sterile Pre-set 1D Barcoded Cryovials, Blue Caps	\$240.40
BX88-6104	1.0mL Sterile Pre-set 1D Barcoded Cryovials, Yellow Caps	\$240.40
BX88-6105	1.0mL Sterile Pre-set 1D Barcoded Cryovials, Purple Caps	\$240.40
BX88-6150	1.5mL Sterile Pre-set 1D Barcoded Cryovials, White Caps	\$240.40
BX88-6151	1.5mL Sterile Pre-set 1D Barcoded Cryovials, Red Caps	\$240.40
BX88-6152	1.5mL Sterile Pre-set 1D Barcoded Cryovials, Green Caps	\$240.40
BX88-6153	1.5mL Sterile Pre-set 1D Barcoded Cryovials, Blue Caps	\$240.40
BX88-6154	1.5mL Sterile Pre-set 1D Barcoded Cryovials, Yellow Caps	\$240.40
BX88-6155	1.5mL Sterile Pre-set 1D Barcoded Cryovials, Purple Caps	\$240.40



BX88-6050

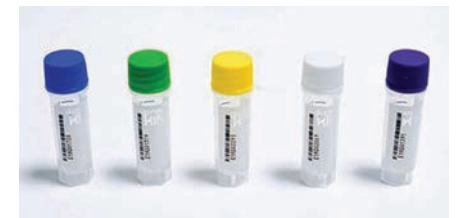

BX88-6100



BX88-6150

BioX Tricode Cryovials 1D and 2D

- Clear polypropylene
- Sterile pre-set 1D and 2D barcoded with internal or external thread and caps assembled
- Writing patch and marked graduations
- 25 cryovials/bag, 20 bags/pack, 2 packs/case, price/case/1000

BioX Barcoded Cryovials 2D

Cat. No.	Description	List Price
BX88-9050	0.5mL Sterile Pre-set 2D Barcoded (Side & Bottom) Cryovials, White Caps	\$263.04
BX88-9051	0.5mL Sterile Pre-set 2D Barcoded (Side & Bottom) Cryovials, Red Caps	\$263.04
BX88-9052	0.5mL Sterile Pre-set 2D Barcoded (Side & Bottom) Cryovials, Green Caps	\$263.04
BX88-9053	0.5mL Sterile Pre-set 2D Barcoded (Side & Bottom) Cryovials, Blue Caps	\$263.04
BX88-9054	0.5mL Sterile Pre-set 2D Barcoded (Side & Bottom) Cryovials, Yellow Caps	\$263.04
BX88-9055	0.5mL Sterile Pre-set 2D Barcoded (Side & Bottom) Cryovials, Purple Caps	\$263.04



BX88-9050

BioX Tricode Barcoded Cryovials 1D and 2D

Cat. No.	Description	List Price
BX88-9100	1.0mL Sterile Pre-set 1D & 2D Barcoded Cryovials, EX Thread, White Caps	\$263.04
BX88-9101	1.0mL Sterile Pre-set 1D & 2D Barcoded Cryovials, EX Thread, Red Caps	\$263.04
BX88-9102	1.0mL Sterile Pre-set 1D & 2D Barcoded Cryovials, EX Thread, Green Caps	\$263.04
BX88-9103	1.0mL Sterile Pre-set 1D & 2D Barcoded Cryovials, EX Thread, Blue Caps	\$263.04
BX88-9104	1.0mL Sterile Pre-set 1D & 2D Barcoded Cryovials, EX Thread, Yellow Caps	\$263.04
BX88-9105	1.0mL Sterile Pre-set 1D & 2D Barcoded Cryovials, EX Thread, Purple Caps	\$263.04
BX88-9150	1.5mL Sterile Pre-set 1D & 2D Barcoded Cryovials, EX Thread, White Caps	\$263.04
BX88-9151	1.5mL Sterile Pre-set 1D & 2D Barcoded Cryovials, EX Thread, Red Caps	\$263.04
BX88-9152	1.5mL Sterile Pre-set 1D & 2D Barcoded Cryovials, EX Thread, Green Caps	\$263.04
BX88-9153	1.5mL Sterile Pre-set 1D & 2D Barcoded Cryovials, EX Thread, Blue Caps	\$263.04
BX88-9154	1.5mL Sterile Pre-set 1D & 2D Barcoded Cryovials, EX Thread, Yellow Caps	\$263.04
BX88-9155	1.5mL Sterile Pre-set 1D & 2D Barcoded Cryovials, EX Thread, Purple Caps	\$263.04
BX88-9200	2.0mL Sterile Pre-set 1D & 2D Barcoded Cryovials, EX Thread, White Caps	\$374.48
BX88-9201	2.0mL Sterile Pre-set 1D & 2D Barcoded Cryovials, EX Thread, Red Caps	\$374.48
BX88-9202	2.0mL Sterile Pre-set 1D & 2D Barcoded Cryovials, EX Thread, Green Caps	\$374.48
BX88-9203	2.0mL Sterile Pre-set 1D & 2D Barcoded Cryovials, EX Thread, Blue Caps	\$374.48
BX88-9204	2.0mL Sterile Pre-set 1D & 2D Barcoded Cryovials, EX Thread, Yellow Caps	\$374.48
BX88-9205	2.0mL Sterile Pre-set 1D & 2D Barcoded Cryovials, EX Thread, Purple Caps	\$374.48
BX88-9210	2.0mL Sterile Pre-set 1D & 2D Barcoded Cryovials, IN Thread, White Caps	\$402.20
BX88-9211	2.0mL Sterile Pre-set 1D & 2D Barcoded Cryovials, IN Thread, Red Caps	\$402.20
BX88-9212	2.0mL Sterile Pre-set 1D & 2D Barcoded Cryovials, IN Thread, Green Caps	\$402.20
BX88-9213	2.0mL Sterile Pre-set 1D & 2D Barcoded Cryovials, IN Thread, Blue Caps	\$402.20
BX88-9214	2.0mL Sterile Pre-set 1D & 2D Barcoded Cryovials, IN Thread, Yellow Caps	\$402.20
BX88-9215	2.0mL Sterile Pre-set 1D & 2D Barcoded Cryovials, IN Thread, Purple Caps	\$402.20
BX88-9500	5.0mL Sterile Pre-set 1D & 2D Barcoded Cryovials, EX Thread, White Caps	\$407.44
BX88-9501	5.0mL Sterile Pre-set 1D & 2D Barcoded Cryovials, EX Thread, Red Caps	\$407.44
BX88-9502	5.0mL Sterile Pre-set 1D & 2D Barcoded Cryovials, EX Thread, Green Caps	\$407.44
BX88-9503	5.0mL Sterile Pre-set 1D & 2D Barcoded Cryovials, EX Thread, Blue Caps	\$407.44
BX88-9504	5.0mL Sterile Pre-set 1D & 2D Barcoded Cryovials, EX Thread, Yellow Caps	\$407.44
BX88-9505	5.0mL Sterile Pre-set 1D & 2D Barcoded Cryovials, EX Thread, Purple Caps	\$407.44

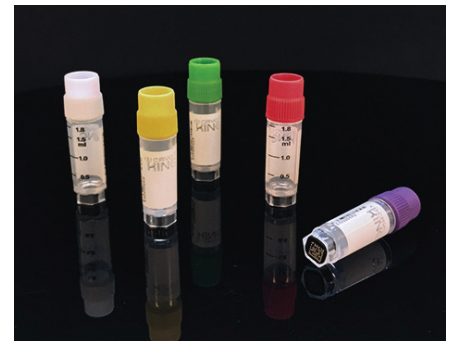

BX88-9200



BX88-9210



BX88-9500

BioX Pre-set Cryovials 1D

Cat. No.	Description	List Price
BX88-6200	2.0mL Sterile Pre-set 1D Barcoded Cryovials, EX Thread, White Caps	\$240.40
BX88-6201	2.0mL Sterile Pre-set 1D Barcoded Cryovials, EX Thread, Red Caps	\$240.40
BX88-6202	2.0mL Sterile Pre-set 1D Barcoded Cryovials, EX Thread, Green Caps	\$240.40
BX88-6203	2.0mL Sterile Pre-set 1D Barcoded Cryovials, EX Thread, Blue Caps	\$240.40
BX88-6204	2.0mL Sterile Pre-set 1D Barcoded Cryovials, EX Thread, Yellow Caps	\$240.40
BX88-6205	2.0mL Sterile Pre-set 1D Barcoded Cryovials, EX Thread, Purple Caps	\$240.40
BX88-6210	2.0mL Sterile Pre-set 1D Barcoded Cryovials, IN Thread, White Caps	\$270.72
BX88-6211	2.0mL Sterile Pre-set 1D Barcoded Cryovials, IN Thread, Red Caps	\$270.72
BX88-6212	2.0mL Sterile Pre-set 1D Barcoded Cryovials, IN Thread, Green Caps	\$270.72
BX88-6213	2.0mL Sterile Pre-set 1D Barcoded Cryovials, IN Thread, Blue Caps	\$270.72
BX88-6214	2.0mL Sterile Pre-set 1D Barcoded Cryovials, IN Thread, Yellow Caps	\$270.72
BX88-6215	2.0mL Sterile Pre-set 1D Barcoded Cryovials, IN Thread, Purple Caps	\$270.72
BX88-6500	5.0mL Sterile Pre-set 1D Barcoded Cryovials, EX Thread, White Caps	\$304.66
BX88-6501	5.0mL Sterile Pre-set 1D Barcoded Cryovials, EX Thread, Red Caps	\$304.66
BX88-6502	5.0mL Sterile Pre-set 1D Barcoded Cryovials, EX Thread, Green Caps	\$304.66
BX88-6503	5.0mL Sterile Pre-set 1D Barcoded Cryovials, EX Thread, Blue Caps	\$304.66
BX88-6504	5.0mL Sterile Pre-set 1D Barcoded Cryovials, EX Thread, Yellow Caps	\$304.66
BX88-6505	5.0mL Sterile Pre-set 1D Barcoded Cryovials, EX Thread, Purple Caps	\$304.66



BX88-6200



BX88-6210

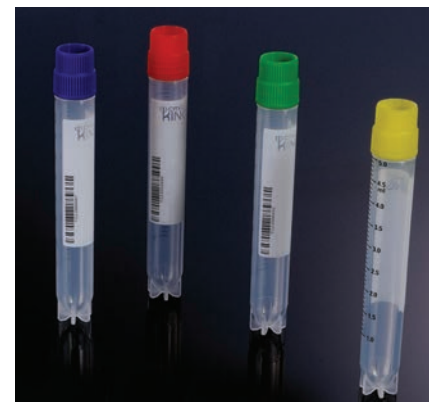

BX88-6500

BioX Tricode SBS Format Combo External Thread

- Screw top minitubes with caps
- Vials loaded into a barcoded 96-well rack
- Eternally threaded jacketed cryovials
- Feature 2D barcodes on bottom with matching 1D and human readable barcodes on the side
- 96 tubes/rack, 10 racks/case, price/case



BX89-8055



BX89-8205



BX89-5143

Tricode SBS Format Combo External Thread

Cat. No.	Description	List Price
BX89-8055	500µL SBS Format Screw Top Minitubes, Purple Caps, 960/case	\$685.92
BX89-8105	1.0mL SBS Format Screw Top Minitubes, Purple Caps, 960/case	\$750.60
BX89-8205	2.0mL SBS Format Screw Top Minitubes, Purple Caps, Loaded into a Barcoded 48-well Rack, 480/case	\$374.48
BX89-5143	1.4mL SBS Format Screw Top Minitubes, Blue Caps, Loaded into a Barcoded 48-well Rack, 960/case	\$750.60

BioDot Cryogenic Vials and Cap Inserts

- Certified RNase, DNase, Pyrogen and DNA free
- Store at temperatures as low as -196°C .
- Only for in the gas phase of liquid nitrogen
- Caps and tubes are made of polypropylene material
- Silicone seal fitted inside of cap ensures positive seal at any temperature
- Cap inserts available in different colors
- Super fast 1 1/4 turn thread design
- Thick wall makes vial almost unbreakable
- Large white marking area
- Excellent clarity makes sample easy to see
- Externally threaded round bottom vials can be centrifuged to 17,000g
- Internally threaded round bottom vials can be centrifuged to 14,000g
- Many sizes available as self-standing with universal locking base



T301-1



T301-5



T308-5A



T308-1

Cat. No.	Description	List Price
Sterile Internal Thread with Silicone O-ring Seal		
T301-1	Cryogenic Vial with Silicone O-Ring Seal, 1.2mL, 12.5 x 41mm, Self Standing, Internal Thread, Polypropylene, Marking Area, 1000 Per Case	\$399.19
T301-2	Cryogenic Vial with Silicone O-Ring Seal, 2.0mL, 12.5 x 49mm, Self Standing, Internal Thread, Polypropylene, Marking Area, 1000 Per Case	\$396.88
T301-3	Cryogenic Vial with Silicone O-Ring Seal, 2.0mL, 12.5 x 48mm, Round Bottom, Internal Thread, Polypropylene, Marking Area, 1000 Per Case	\$396.96
T301-4	Cryogenic Vial with Silicone O-Ring Seal, 2.0mL, 12.5 x 70mm, Round Bottom, Internal Thread, Polypropylene, Marking Area, 1000 Per Case	\$446.28
T301-4A	Cryogenic Vial with Silicone O-Ring Seal, 2.0mL, 12.5 x 72mm, Self-Standing, Internal Thread, Polypropylene, Marking Area, 1000 Per Case	\$446.28
T301-5	Cryogenic Vial with Silicone O-Ring Seal, 5mL 12.5 x 90mm, Round Bottom, Internal Thread, Polypropylene, White Marking Area, 1000 Per Case	\$540.84
Sterile External Thread with Lip Seal + O-ring Seal		
T308-1A	Cryogenic Vial with Lip and Silicone Washer Seal, 1.2mL, 12.5 x 42mm, Self-Standing, External Thread, Polypropylene, Marking Area, 1000 Per Case	\$422.47
T308-2	Cryogenic Vial with Lip and Silicone Washer Seal, 2.0mL, 12.5 x 47mm, Round Bottom, External Thread, Polypropylene, Marking Area, 1000 Per Case	\$422.47
T308-2A	Cryogenic Vial with Lip and Silicone Washer Seal, 2.0mL, 12.5 x 49mm, Self-Standing, External Thread, Polypropylene, Marking Area, 1000 Per Case	\$422.47
T308-3A	Cryogenic Vial with Lip and Silicone Washer Seal, 3.0mL, 12.5 x 71mm, Self-Standing, External Thread, Polypropylene, Marking Area, 1000 Per Case	\$443.54
T308-4A	Cryogenic Vial with Lip and Silicone Washer Seal, 4.0mL, 12.5 x 77mm, Self-Standing, External Thread, Polypropylene, Marking Area, 1000 Per Case	\$481.98
T308-5A	Cryogenic Vial with Lip and Silicone Washer Seal, 5.0ml, 12.5 x 91mm, Self-Standing, External Thread, Polypropylene, Marking Area, 1000 Per Case	\$535.62

Cryogenic Vials, Inserts and Closures

Cat. No.	Description	List Price
Sterile External Thread with Lip Seal		
T309-1A	Cryogenic Vial with Lip Seal, 1.2mL, 12.5 x 42mm, Self-Standing, External Thread, Polypropylene, Marking Area, 1000 Per Case	\$314.57
T309-2	Cryogenic Vial with Lip Seal, 2.0mL, 12.5 x 47mm, Round Bottom, External Thread, Polypropylene, Marking Area, 1000 Per Case	\$314.57
T309-2A	Cryogenic Vial with Lip Seal, 2.0mL, 12.5 x 47mm, Self-Standing, External Thread, Polypropylene, Marking Area, 1000 Per Case	\$314.57
T309-3A	Cryogenic Vial with Lip Seal, 3.0mL, 12.5 x 71mm, Self-Standing, External Thread, Polypropylene, Marking Area, 1000 Per Case	\$327.70
T309-4A	Cryogenic Vial with Lip Seal, 4.0mL, 12.5 x 77mm, Self-Standing, External Thread, Polypropylene, Marking Area, 1000 Per Case	\$351.11
T309-5A	Cryogenic Vial with Lip Seal, 5.0mL, 12.5 x 91mm, Self-Standing, External Thread, Polypropylene, Marking Area, 1000 Per Case	\$395.02
Sterile External Thread with Silicone Washer Seal		
T310-10A	External Threaded Cryogenic Vial with Polyethylene Cap with Silicone Washer Seal, Natural, Sterile, Self-Standing, 10mL, 50 per Bag	\$ 34.19
T310-1A	External Threaded Cryogenic Vial with Silicone Washer Cap, Natural, Sterile, Self Standing, 1.2mL, 100 per Bag	\$ 40.81
T310-2	External Threaded Cryogenic Vial with Silicone Washer Cap, Natural, Sterile, Round Bottom, 2.0mL, 100 per Bag	\$ 40.81
T310-2A	External Threaded Cryogenic Vial with Silicone Washer Cap, Natural, Sterile, Self Standing, 2.0mL, 100 per Bag	\$ 40.81
T310-3A	External Threaded Cryogenic Vial with Silicone Washer Cap, Natural, Sterile, Self Standing, 3.0mL, 100 per Bag	\$ 41.40
T310-4A	External Threaded Cryogenic Vial with Silicone Washer Cap, Natural, Sterile, Self Standing, 4.0mL, 100 per Bag	\$ 45.61
T310-5A	External Threaded Cryogenic Vial with Silicone Washer Cap, Natural, Sterile, Self Standing, 5mL, 100 per Bag	\$ 49.82
Sterile Internal Thread with Silicone Washer Seal		
T311-1	Internal Threaded Cryogenic Vial with Silicone Washer Cap, Natural, Sterile, Self Standing, 1.2mL, 100 per Bag	\$ 39.48
T311-2	Internal Threaded Cryogenic Vial with Silicone Washer Cap, Natural, Sterile, Self Standing, 2.0mL, 100 per Bag	\$ 39.65
T311-3	Internal Threaded Cryogenic Vial with Silicone Washer Cap, Natural, Sterile, Round Bottom, 2.0mL, 100 per Bag	\$ 39.65
T311-4	Internal Threaded Cryogenic Vial with Silicone Washer Cap, Natural, Sterile, Round Bottom, 4.0mL, 100 per Bag	\$ 46.00
T311-4A	Internal Threaded Cryogenic Vial with Silicone Washer Cap, Natural, Sterile, Self Standing, 4.0mL, 100 per Bag.	\$ 46.00
T311-5	Internal Threaded Cryogenic Vial with Silicone Washer Cap, Natural, Sterile, Round Bottom, 5mL, 100 per Bag	\$ 53.75
Color-coded Cap Inserts		
T312-1	Color Coded Cap Inserts, White, 500 per Bag	\$ 20.37
T312-2	Color Coded Cap Inserts, Blue, 500 per Bag	\$ 20.37
T312-3	Color Coded Cap Inserts, Red, 500 per Bag	\$ 20.37
T312-4	Color Coded Cap Inserts, Green, 500 per Bag	\$ 20.37
T311-5	Color Coded Cap Inserts, Yellow, 500 per Bag	\$ 20.37
T312-7	Color Coded Cap Inserts, Assorted, 500 per Bag	\$ 20.37
T312-8	Color Coded Cap Inserts, Tan, 500 per Bag	\$ 20.37
T312-9	Color Coded Cap Inserts, Gray, 500 per Bag	\$ 20.37
T312-10	Color Coded Cap Inserts, Lilac, 500 per Bag	\$ 20.37
T312-11	Color Coded Cap Inserts, Burnt Orange, 500 per Bag	\$ 20.37
T312-13	Color Coded Cap Inserts, Purple, 500 per Bag	\$ 20.37
T312-14	Color Coded Cap Inserts, Pink, 500 per Bag	\$ 20.37



T309-1



T309-5A



T310-5A



T310-1



T311-1



T311-5

Cryogenic Freezer and Storage Boxes

BioX Polycarbonate Freezer Box with Removable Lid

- Numeric grid for identification purposes
- Assorted colors: red, yellow, green, blue and white

BioX Polycarbonate Freezer Box with Removable Lid		
Cat. No.	Description	List Price
BX90-9009-1	2" 81-Well PC Freezer Boxes with Lids, (132 x 132 x 53mm), 20/case	\$203.90
BX90-9210-1	2" 100-Well PC Freezer Boxes with Lids, (132 x 132 x 53mm), 20/case	\$203.90
BX90-9381	3.75" 81-Well PC Freezer Boxes with Lids, (132 x 132 x 53mm), 20/case	\$203.90
BX90-9250-1	2" 25-Well PC Freezer Boxes with Lids, (75 x 75 x 52mm), 30/case	\$203.90

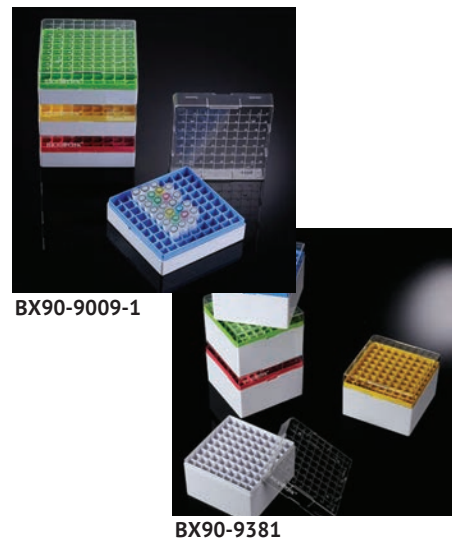

BX90-9009-1

BX90-9381

BioX Autoclavable Polycarbonate Cryogenic Boxes

- 100-well blue polycarbonate scan-ready
- Autoclavable cryogenic storage box
- 133 x 133x 36mm
- Marked numeric grid for identification purposes
- 6 boxes/pack, 2 packs/case, price/case/12

BioX Autoclavable Polycarbonate Cryogenic Boxes		
Cat. No.	Description	List Price
BX98-0113	1" 100-Well PC Scan-Ready Autoclavable Cryogenic Box, Blue	\$122.94
BX98-0213	2" 100-Well PC Scan-Ready Autoclavable Cryogenic Box, Blue	\$122.94

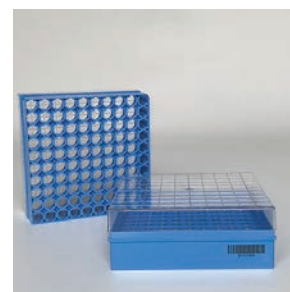

BX98-0113

CryoSette™ Frozen Tissue Storage Boxes and Accessories

Cat. No.	Description	List Price
M956-21W	CryoSette™ Frozen Tissue Storage Boxes, Designed to Contain 21 Frozen Tissue CryoSette Containers, Polypropylene, Suitable for Cryogenic Storage	\$165.40
M956-40B	CryoSette Frozen Tissue Storage Box, 40 Place, Polycarbonate, Frosted Cover, Temperature Range -196°C to 121°C, Autoclavable, 133 x 133 x 52mm (H), Suitable only in Gas Phase LN2, 10 Storage Boxes Per Case	\$175.09
M956COV	CryoSette Transparent Plastic ID Label Cover for M956O CryoSette Frozen Tissue Container, 100 per Pack	\$ 40.00
M956LAB	Cardboard ID Label for CryoSette M956O, 100 Per Pack	\$115.85
M956O	CryoSette Frozen Tissue Storage Container, Orange and White, Base is Acetal, Screw Closure is High-density Polyethylene, Offers Sample Specimen Storage in Upright Chest Freezers and Vapor-Phase Dewar Flasks at -196°C but not in LN2 Liquid Phase, Chamber Dimensions 21mm O.D. x 18mm ID x 10.5mm H, Total CryoSette Dimensions: 24 mm x 38 mm x 11 mm H., 95 kPa Tested, 250 Per Case	\$553.50
M956SEP	Cardboard Separator for M956-40B CryoSette 40 Place Storage Box, 6 Per Case	\$ 22.50
M957B	Cap Insert for CryoSette, Blue, Polypropylene, 5.3mm in Diameter, 500 Per Case	\$ 41.98
M957G	Cap Insert for CryoSette, Green, Polypropylene, 5.3mm in Diameter, 500 Per Case	\$ 41.98
M957L	Cap Insert for CryoSette, Lilac, Polypropylene, 5.3mm in Diameter, 500 Per Case	\$ 41.98
M957R	Cap Insert for CryoSette, Red, Polypropylene, 5.3mm in Diameter, 500 Per Case	\$ 41.98
M957Y	Cap Insert for CryoSette, Yellow, Polypropylene, 5.3mm in Diameter, 500 Per Case	\$ 41.98

Polycarbonate and Polypropylene Freezer Boxes

Cryostore™ Autoclavable Polycarbonate Cryogenic Boxes

- Designed to be used at temperatures between –196°C and +121°C
- Autoclavable at 120°C, 15 psig (1 bar) for 20 minutes
- A transparent cover to see contents, and keyed to the base to prevent misalignment
- Printed with a series of squares

Cryostore™ Autoclavable Polycarbonate Cryogenic Boxes		
Cat. No.	Description	List Price
T314-2100B	Cryovial Plastic Storage Boxes, 1.2mL and 2mL, 100 Place, Blue	\$11.84
T314-2100G	Cryovial Plastic Storage Boxes, 1.2mL and 2mL, 100 Place, Green	\$11.84
T314-2100R	Cryovial Plastic Storage Boxes, 1.2mL and 2mL, 100 Place, Red	\$11.84
T314-2100Y	Cryovial Plastic Storage Boxes, 1.2mL and 2mL, 100 Place, Yellow	\$11.84

Cryostore™ Polycarbonate Cryovial 81-Well Storage Boxes

- Holds 81 cryogenic vials of 1mL to 2 mL sizes
- Made of polycarbonate, resistant to temperatures between –196°C and 121°C
- Transparent cover with printed numerical grid from 1 to 81
- Comes in four different colored grids (blue, green, red and yellow)
- Stackable with drain holes on the base and vent holes on the lids
- Vial picker included with every box

Cryostore™ Polycarbonate Cryovial 81-Well Storage Boxes		
Cat. No.	Description	List Price
T314-281B	Cryogenic 81-Well Storage Boxes for 1.2mL to 2.0mL Vials, Blue, 5.25" x 5.25" x 2.06"	\$11.40
T314-281G	Cryogenic 81-Well Storage Boxes for 1.2mL to 2.0mL Vials, Green, 5.25" x 5.25" x 2.06"	\$11.40
T314-281R	Cryogenic 81-Well Storage Boxes for 1.2mL to 2.0mL Vials, Red, 5.25" x 5.25" x 2.06"	\$11.40
T314-281Y	Cryogenic 81-Well Storage Boxes for 1.2mL to 2.0mL Vials, Yellow, 5.25" x 5.25" x 2.5"	\$11.40

BiOX Polypropylene Freezer Boxes with Removable Lids

- Numeric grid for identification purposes
- Assorted colors (clear, pink, blue, green and yellow)

BiOX Polypropylene Freezer Boxes with Removable Lids		
Cat. No.	Description	List Price
BX90-9081	2" 81-Well Polypropylene Freezer Box, 132 x 132 x 53mm, 20/case	\$ 80.60
BX90-9100	2" 100-Well Polypropylene Freezer Box, 141 x 153.7 x 54.6mm, 20/case	\$106.80
BX90-9200	2" 100-Well Polypropylene Freezer Box, 132 x 132 x 53mm, 20/case	\$106.80
BX90-9025-1	2" 25-Well Polypropylene Freezer Box, 75 x 75 x 52mm, 30/case	\$ 80.60



BX90-9025-1



BX90-9100

BioX Cardboard Freezer Boxes		
Cat. No.	Description	List Price
Superior White Cardboard Freezer Boxes		
BX90-1281	2" 81-well Cardboard Freezer Boxes, 5 boxes/pack, 20 packs/case, price/case/100	\$256.36
BX90-1200	2" 100-well Cardboard Freezer Boxes, 5 boxes/pack, 20 packs/case, price/case/100	\$256.36
BX90-1381	3" 81-well Cardboard Freezer Boxes, 5 boxes/pack, 20 packs/case, price/case/100	\$312.76
BX90-1300	3" 100-well Cardboard Freezer Boxes, 5 boxes/pack, 20 packs/case, price/case/100	\$312.76
White Plasti-Coat™ Cardboard Freezer Boxes		
BX90-2281	2" 81-well Cardboard Freezer Boxes, 5 boxes/pack, 20 packs/case, price/case/100	\$221.02
BX90-2200	2" 100-well Cardboard Freezer Boxes, 5 boxes/pack, 20 packs/case, price/case/100	\$221.02
BX90-2381	3" 81-well Cardboard Freezer Boxes, 5 boxes/pack, 20 packs/case, price/case/100	\$221.02
BX90-2300	3" 100-well Cardboard Freezer Boxes, 5 boxes/pack, 20 packs/case, price/case/100	\$221.02
Cryo-Color™ Cardboard Freezer Boxes - Assorted Colors (Red, Blue, Green, Yellow & White)		
BX90-5281	2" 81-well Cardboard Freezer Boxes, 5 boxes/pack, 20 packs/case, price/case/100	\$300.82
BX90-5200	2" 100-well Cardboard Freezer Boxes, 5 boxes/pack, 20 packs/case, price/case/100	\$300.82
BX90-1536	5" 36-well Cardboard Freezer Boxes (for 1.5mL Tubes), 5 boxes/pack, 20 packs/case, price/case/100	\$433.12
BX90-5016	5" 16-well Cardboard Freezer Boxes (for 5.0mL Tubes), 5 boxes/pack, 20 packs/case, price/case/100	\$433.12
Water Resistant ID-Color™ Cardboard Freezer Boxes - Hinged Lid and Divider Made of PP Material, Marked Alphanumeric Grid for Identification, Assorted Colors (Red, Blue, Green, Yellow and White)		
BX90-8100	1" 100-well Water Resistant Cardboard Freezer Boxes, 5 boxes/pack, 4 packs/case, price/case/20	\$106.09
BX90-8200	1" 81-well Water Resistant Cardboard Freezer Boxes, 5 boxes/pack, 4 packs/case, price/case/20	\$106.09
BX90-8281	2" 100-well Water Resistant Cardboard Freezer Boxes, 5 boxes/pack, 4 packs/case, price/case/20	\$106.09
BX90-8381	3" 81-well Water Resistant Cardboard Freezer Boxes, 5 boxes/pack, 4 packs/case, price/case/20	\$106.09



BX90-1281



BX90-1381



BX90-2200



BX90-2300



BX90-8200

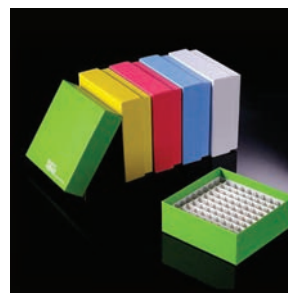

BX90-5281



BX90-5016



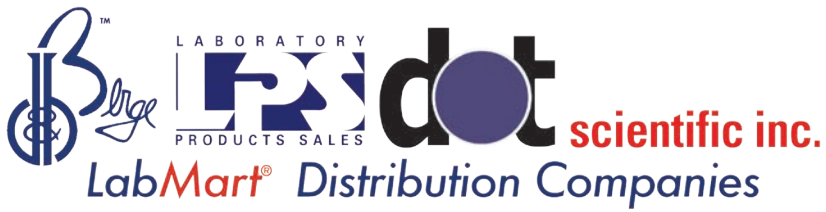

dot scientific inc.

Phone : 800.878.1785
Email : orders@dotscientific.com
Website : www.dotscientific.com
Federal ID# : 38-2757001



Phone : 800.388.0166
Email : info@LPSinc.com
Website : LPSinc.com
Federal ID# : 16-1274974



Phone : 732.757.9764
Email : info@labmart.com
Website : labmart.com
Federal ID# : 87-3691687

